

**Bachelor of Science
(B.Sc. - CBZ)**

**Atomic Structure, Bonding, General
Organic Chemistry & Aliphatic
Hydrocarbons
(DBSZCO101T24)**

**Self-Learning Material
(SEM 1)**



**Jaipur National University
Centre for Distance and Online Education**

**Established by Government of Rajasthan
Approved by UGC under Sec 2(f) of UGC ACT 1956
&
NAAC A+ Accredited**

PREFACE

Welcome to the world of chemistry, where the wonders of the molecular realm come alive. This book is intended to be your guide through the captivating landscape of chemical principles, reactions, and applications. Whether you are a student commencing your journey in chemistry or a seasoned practitioner looking to deepen your information, this text aims to provide a complete and attractive resource.

This book is prepared to enable a clear and logical progression of topics. We start with the fundamental concepts of atoms, molecules, and chemical bonds, laying a solid foundation for more complex subjects. As you move through the chapters, you will explore various branches of chemistry, including organic, inorganic, physical, and analytical chemistry. Each section is enriched with real-world examples, detailed illustrations, and practical applications that highlight the relevance of chemistry in our lives.

Thank you for selecting this book as your cohort in exploring the marvels of chemistry. May it serve as a valuable resource and a source of stimulation throughout your studies and beyond.

TABLE OF CONTENTS

Unit	Topic	Page No.
1	Atomic Structure	1- 11
2	Quantum Mechanics	12 – 23
3	Significance of Quantum Numbers	24 – 34
4	Ionic Bonding	35 – 41
5	Covalent Bonding	42 – 52
6	Molecular Orbital Theory	53 – 66
7	Electronic Effects	67 – 75
8	Reactive Intermediates	76 – 87
9	Aromaticity	88 – 94
10	Stereochemistry - I	95 – 101
11	Stereochemistry – II	102 – 106
12	Stereochemistry - III	107 – 124
13	Alkanes	125 – 132
14	Alkenes and Alkynes	133 – 151

UNIT – 1

Atomic Structure

Objectives

- Review Bohr's theory and its limitations.
- Understand the dual behaviour of matter and radiation.
- Explore de Broglie's relation.
- Learn about the Heisenberg Uncertainty Principle.
- Study the hydrogen atom spectra.
- Recognize the need for a new approach to atomic structure

1.1 Bohr's Model of Atom

As per the Bohr's atomic model there is a positively charged centre which is called nucleus and negatively charged species called electrons rotate around the nucleus in orbit with a definite size and energy. According to Bohr by gaining or losing energy (as photons), the electrons jump in-between orbits. Bohr explained that the electrons present in shells that are far from the nucleus would have more energy, and the electrons present in shells that are near the nucleus will have less energy. Also, electrons present in lower orbits will be the most stable.

In Rutherford's model of an atom, the electrons were in random motion, and the model didn't define stability of an atom. Bohr's atomic model shows similarity to solar system, where planets orbit the sun and gravity is force of attraction between the planets and the sun, while in between electron and nucleus electrostatic force of attraction.

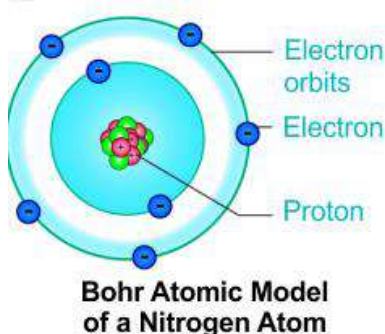

Figure 1.1: Atomic model of Bohr

1.1.1 Postulates of Bohr's Atomic Model

1. An atom contains tiny, heavy and positively charged centre called nucleus and electrons revolve around it in circular orbits.
2. Electrons rotate in orbits with a set energy value, out of various circular orbits theoretically feasible around the nucleus. These orbits are referred to as stationary states or energy levels. When an electron is said to be stationary, it signifies that its energy remains constant over time and is fixed in that specific orbit. . The number given to different energy levels are 1, 2, 3, 4... or denoted by symbols as K, L, M, N, O, P....
3. When electrons revolve around the orbital's which have fixed values of energy, then electron have some certain or distinct amount of energy and some own energy, which explain the concept of quantized energy of electron.
4. When electrons of an atom are at lowest or normal energy level, they continue revolve around their orbital without losing energy because energy cannot be constantly lost or acquired. It is referred to as an atom's normal or ground state.
5. Only when electrons leap from one orbit to the next can they produce or absorb energy. Whenever energy is transfer to an atom through high temperature and electric discharge, an electron absorb a minimum amount of energy and excite from lower energy level to level with higher energy is termed as excited state of atom. Because the electron's period of existence in the higher energy state is limited so electron returns towards lower energy level instantly by releasing energy as light of an appropriate frequency or wavelength.
6. A minimal quantity of energy that is connected to every energy level so energy is released or absorbed in distinct quantity is called quanta or photons. This indicates that an electron's energy can only changes suddenly as it moves from one to another energy level.

1.1.2 Distribution of Electrons in Orbits

Electrons in an atom revolving around the nucleus are present in circular orbits. Electrons occupy the orbitals in the ground state in the sequence of increasing energy. It indicates that electrons move towards higher energy orbits after filling lower one.

The shell can have maximum number of electrons is $2n^2$, where n equals to number of energy shells. 1st energy shell is K, the second energy shell is L, the third energy shell is M, and so on. Therefore, K, L, M and N shell can have a maximum 2, 8, 18 and 32 electrons respectively.

1.1.3 Uses of Bohr's Model

- Explain stability of the atom.
- For describe hydrogen atom line spectrum.
- To calculate energy of an electron in H-atom and H-like particles.
- To deduce Rydberg's formula

1.1.4 Limitations of Bohr's Model are as follows

- The line spectra of H- atoms and H-like particles which have single electron can be explained by Bohr's theory, but Bohr's does not explain line spectra multi electrons system.
- Splitting of spectral lines in magnetic field is known as Zeeman effect and in electric field its known as Stark effect. Bohr's could not explain this type of splitting spectral lines.
- Bohr model only applicable for one dimensional or flat molecule, not for three dimensional. For example in covalent molecules the bonds have directional properties and fixed shapes which are not explained by this model.
- Bohr was not able to explain the concept of de Broglie's and Uncertainty principle of Heisenberg.
- Concept of elliptical orbits does not explain.
- It did not consider electron spin energy.
- Bohr cannot give any explanation of angular momentum is an integral multiple of $h^2\pi$.

1.2 Dual Nature of Radiation and Matter

The French physicist Louis de Broglie introduced **De Broglie relation** is a physical property of electrons in 1924. The relationship between an electron's momentum and wavelength is represented by the formula $p = h/\lambda$, where λ denotes wavelength and h denotes the Planck

constant. This relationship used to determine how much energy an electron releases upon a collision with a photon or another particle.

According to the De Broglie's relationship, matter like light, has wave-like and particle-like properties. This nature has been described as dual matter behaviour. De Broglie derived a relationship between momentum and wavelength based on his observations. The De Broglie Relationship is mathematical equation explain probability of a particle having a particular wavelength. It is used in quantum mechanics and quantum physics to explain how particles can have different wavelengths.

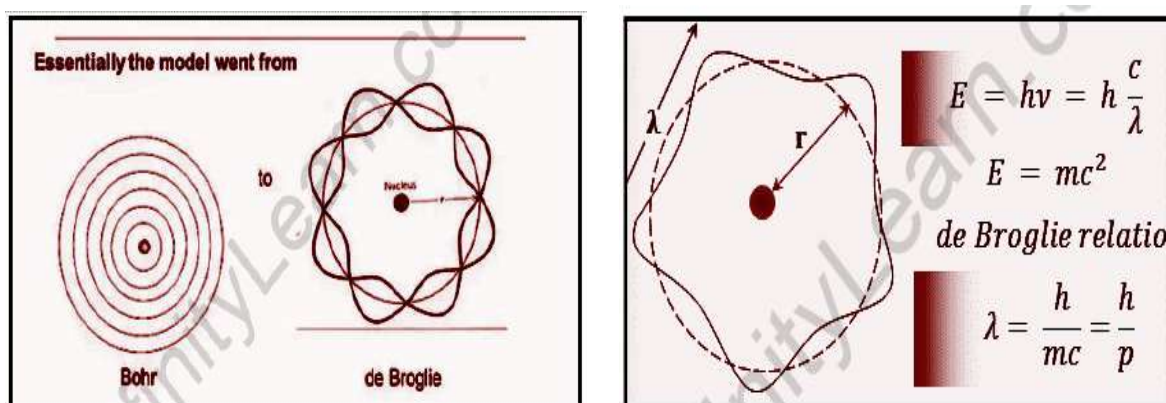

Figure: 1.2: De Broglie's Model

Behavior of electrons in atoms explained by this model. In this model, electrons are represented as waves, and protons are represented as particles. The De Broglie's relationship provides a formula for calculating the wavelength for an electron moving through space and time according to its momentum or speed. The de Broglie relation states photons have wavelength equal to the frequency of light. It means light possess dual nature of wave and particle nature. The de Broglie's relationship can be used to measure how much momentum an electron has by measuring how much momentum it takes for an electron to change its wavelength. This equation makes it possible to calculate what wavelength an electron would have if it had more or less energy than its actual value.

De- Broglie Wave equation

Einstein principle: $E=mc^2$ (Particle nature)

Plank's quantum theory: $E=hv$ (Wave nature)

h - Planck's Constant

from both principles

$$E = mc^2 \dots 2$$

On comparing 1 and 2 we get,

$$h\nu = mc^2$$

$$hc/\lambda = mc^2 \quad [v = c/\lambda]$$

$$\lambda = h/mc = h/p$$

λ is wavelength of radiation of frequency

So, according to de Broglie's hypothesis a particle of mass m moving with velocity v must be associated with a matter wave of wavelength λ .

$$\lambda = h/p = h/mv$$

1.2.1 De Broglie inference

- Moving particle wavelength is inversely proportional to its momentum.
- When a material particle is moving, waves are connected to it, If $v=0$ then $\lambda = \infty$
- A particle needs to have a charge, be a part of the de- Broglie wave. So it is known as matter waves.

1.2.2 Derivation of an electron for calculate De- Broglie wavelength

At potential difference of V volts an electron with charge e , mass m attained a final velocity v , if it accelerated from zero velocity.

$$\begin{aligned} \text{K.E} &= \frac{1}{2} mv^2 = \frac{p^2}{2m} \\ \text{work done on electron} &= eV \\ \text{K} &= \frac{p^2}{2m} = eV \\ p &= \sqrt{2mK} = \sqrt{2meV} \\ \lambda &= h/p = h/\sqrt{2mK} = \frac{h}{\sqrt{2meV}} \\ h &= 6.63 \cdot 10^{-34} \text{ Js} \\ m &= 9.1 \cdot 10^{-31} \text{ kg} \\ e &= 1.6 \cdot 10^{-19} \text{ C} \\ \lambda &= \frac{6.63 \cdot 10^{-34}}{\sqrt{2 \cdot 9.1 \cdot 10^{-31} \cdot 1.6 \cdot 10^{-19} V}} \\ &= 12.3 \cdot 10^{-10} / \sqrt{V} \text{ m} = 12.3 / \sqrt{V} \text{ \AA} \end{aligned}$$

1.2.3 Relation between Kinetic energy and De Broglie wavelength

De Broglie wavelength is the distance travelled by a particle during its time of flight, while kinetic energy is the force that moves the particle. When particles are moving in a straight line, there is a constant velocity for them and their de Broglie wavelength will be equal to their velocity. When particles are moving at an angle to the straight line, their de Broglie wavelength will be smaller than their velocity. The shorter the De Broglie wavelength, the greater the kinetic energy because there is less distance that has to be travelled for it to reach its maximum speed. A De Broglie wavelength is proportional to the momentum of the particle. A derivation of K.E. from De Broglie wavelength can be found here:

$$E=hv$$

Kinetic energy is initially provided by:

$$E=1/2mv^2$$

$$=p^2/2m$$

$$p=\sqrt{2mE}$$

where m equals to mass of particle and v is speed, and p denotes momentum.

Wavelength of De Broglie is:

$$\lambda=h/p$$

$$\lambda=h/\sqrt{2mE}$$

1.2.4 Significance of De Broglie's Relationship

- The De Broglie relationship explains dual behaviour of matter applicable only for moving microscopic particles. The particle character is very large for semi-micro and macro particles, while wave character is very small. Because wavelength associated with such particles is so small that it cannot be measured using any of the methods currently available.
- Because the mass of a microscopic particle like an electron is 10^{-31} kg so that wavelength is larger than the atom size and becomes significant.

1.3 Heisenberg's Uncertainty Principle

Heisenberg's uncertainty principle says that it is impossible to determine the position and momentum of a particle simultaneously with accuracy. If momentum measurement is less accurate, the more precisely the location is measured, and vice versa.

1.3.1 Impossible to Measure Both Position and Momentum Simultaneously

For determine the position of an object let us assume that a photon with finite momentum collides with object and returns to measuring device and transfer momenta when the photon collides with the electron. Due to this transfer the momentum of the electron increases. Thus, if position is measured accurately then it will increase the uncertainty in the value of momentum.

Heisenberg's uncertainty principle not applicable for macroscopic object (basketball), since the mass of a photon is much less than that of the ball, there will be a momentum transfer from the photons to the ball while measuring the position of a basketball.

Therefore, it's easy to measure both position and velocity simultaneously.

Position and momentum values are always greater than $h/4\pi$.

Formula: $\Delta x \cdot \Delta p \geq h/4\pi$

Where h = 'Planck constant' = $6.626 \times 10^{-34} \text{ m}^2 \text{ kg / s}$.

Δp = uncertainty in the momentum

Δx = uncertainty in the position

Heisenberg's uncertainty principle also given by following equation

$$\Delta x \cdot \Delta mv \geq h/4\pi \quad (p = mv).$$

1.4 Types of Spectra

A spectrum is a collection of lines of different wavelengths that is produced when electromagnetic energy splits when it passes through a prism or grating. Two categories are identified in the spectrum based on the emission and absorption of radiation.

Table: 1.1 Differences between Emission and Adsorption Spectrum

Emission Spectrum	Absorption Spectrum
1) Obtain when substance emits the radiation.	Obtain when the matter absorbs the radiations.
2) Spectra have black backgrounds with white lines.	Spectra have white background with black lines.
3) Emission spectra obtained when atoms and molecules move from upper energy level to lower energy level.	Absorption spectra obtained when atoms and molecules excites from lower energy level to upper energy level.

Table: 1.2 Differences between Line and Band Spectrum

Line Spectrum	Band Spectrum
1) Contain well defined and sharp lines.	Comprise bands, or closely spaced lines.
2) Representative property of atoms.	Representative property of molecules.
3) Spectra occurs by excitation and de-excitation	Spectra occurs due to vibration and rotation
4) Recognized as atomic spectra.	Recognized as molecular spectra.

1.5 Hydrogen Atomic Spectrum

When hydrogen gas in a discharge tube is subjected to a high potential at low pressure, bright light is released. When passing through a prism and grating it splits into many radiations of different wavelength to form a spectrum is called Hydrogen atomic spectrum. Formation of line spectra is because of electronic transition from one energy level to another. On the basis of range of wavelength the Spectral lines are divided into five series are:

Table: 1.3 Different Spectral Lines

Spectral series	Spectral region	n ₁	n ₂
Lyman series	Ultra-violet	1	2, 3, 4, 5, 6, 7.....
Balmer series	Visible	2	3, 4, 5, 6, 7.....
Paschen series	near infra-red	3	4, 5, 6, 7.....
Brackett series	infra-red	4	5, 6, 7.....
Pfund series	far infra-red	5	6, 7.....

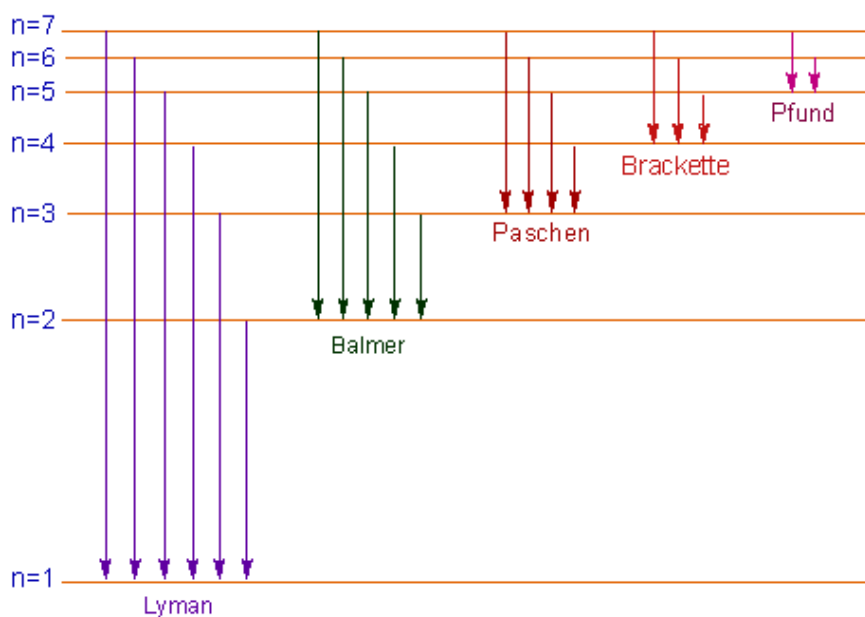

Figure: 1.3 Hydrogen spectrum

Rydberg's equation is used for calculate the wave numbers of spectral lines by:

$$\bar{\nu} = R_H Z^2 \left[\frac{1}{n_1^2} - \frac{1}{n_2^2} \right]$$

Where n₁ and n₂ are the principle orbital quantum numbers associated with electronic transition.

R_H = **Rydberg's constant** = 1,09,677 cm⁻¹

Z = Atomic Number

Line spectra is consider as Finger prints of element, it is characteristic property of every element.

Summary

The content entails a comprehensive review of fundamental concepts in atomic theory. It begins with an examination of Bohr's model of the atom, highlighting its strengths and limitations in explaining atomic behavior. De Broglie's relation, which describes the wave-like properties of matter, is discussed, leading to an exploration of the Heisenberg Uncertainty Principle, which establishes inherent limitations in measuring certain pairs of properties of particles with precision simultaneously.

The discussion extends to the hydrogen atom spectra, which contribute a crucial role in the development of quantum mechanics. Finally, the content emphasizes the necessity of a new approach to atomic structure, suggesting that the limitations of existing theories necessitate further exploration and development of alternative models to better understand the complexities of the atomic realm.

Keywords

Bohr's Model: A model of atomic structure proposed by Niels.

De Broglie principle: A principle proposed by Louis de Broglie that states that every particle or object exhibits wave-like properties.

Hydrogen Atomic Spectrum: The emission or absorption spectrum produced by hydrogen atoms when electrons transition between energy levels.

MCQs

Q.1 Which of the following explain Bohr's model of the atom?

- a) Electrons orbit the nucleus in fixed, circular paths.
- b) Electrons move randomly within the atom.
- c) Electrons are located in specific energy levels around the nucleus.
- d) Electrons exhibit dual nature wave as well as particle.

Answer. A

Q.2 The dual behaviour of matter and radiation refers to:

- a) The tendency of matter to behave as waves and particles under different conditions.
- b) The reflection of light from a surface.

- c) The absorption of energy by matter.
- d) The transmission of sound waves through a medium.

Answer. A

Q.3 De Broglie's relation describes:

- a) The relationship between the energy and frequency of electromagnetic waves.
- b) The wavelength associated with a moving particle.
- c) The behaviour of electrons in orbitals.
- d) The kinetic enthalpy of an electron in an atom.

Answer. A

4. Formula to calculate maximum number of electrons in a subshell of an atom

- a) $2n^2$
- b) $2l + 1$
- c) $4l + 2$
- d) $4l - 2$

Answer. C

Q.5 The hydrogen atom spectra are produced due to:

- a) Electrons transitioning between energy levels.
- b) Electrons occupying fixed positions within the nucleus.
- c) Protons emitting radiation.
- d) Neutrons interacting with electrons.

Answer. A

Self-assessment

1. Explain one limitation of Bohr's theory of the atom.
2. Describe the concept of wave-particle duality.
3. Provide the mathematical expression for de Broglie's relation and explain its significance.
4. How does the Heisenberg Uncertainty Principle challenge classical physics?
5. Briefly explain the significance of hydrogen atom spectra in the development of atomic theory.
6. Why was there a need for a new approach to atomic structure despite the success of Bohr's model?

UNIT – 2

Quantum Mechanics

Objectives

- Understand the fundamental principles governing the behaviour of matter and energy.
- Solve for the wave function of a quantum system independent of time
- Understand the physical interpretation of the wave function and its square.
- Derive the Schrödinger equation for the hydrogen atom and understand its implications.

2.1 Schrödinger Equation: Definition, Derivation, and Applications

Erwin Schrödinger derived a mathematical equation to explain the wave momentum of electron in Hydrogen atom, known as **Schrödinger Equation**.

Schrodinger equation is based on following factors.

1. Classical wave equation,
2. De- Broglie's Hypothesis
3. Energy Conservation

This equation can be consequent from the traditional wave equation and third postulate of quantum mechanics.

By using Classical wave equation Let Consider a wave with velocity v . traveling along x axis in a string

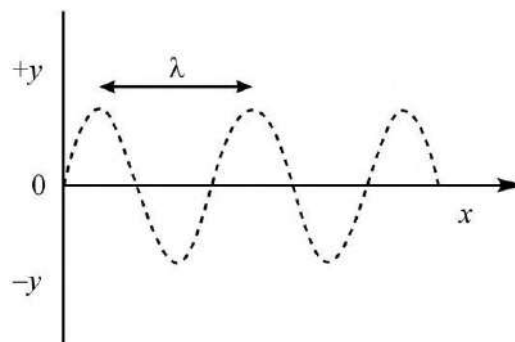

Figure 2.1. Wave motion in a string.

Amplitude of the wave at any time t is the function of displacement x ,

$$\frac{\partial^2 y}{\partial x^2} = \frac{1}{v^2} \frac{\partial^2 y}{\partial t^2} \quad (1)$$

$$y = f(x)f'(t) \quad (2)$$

($f(x)$ and $f'(t)$) are the functions of coordinate x and time (t), correspondingly.

The nature of the function $f(x)$ is explained with the help of standing wave.

- A standing wave is created when a wave moves in one direction and is tied between two locations.
- With or without nodes, the wave produces vibrations in the string as it hits another end and is reflected back with identical velocity but a $-ve$ amplitude.
- Fundamental mode (0 node), first overtone (1 node), or second overtone (2 nodes) can be created by varying the vibration frequency.

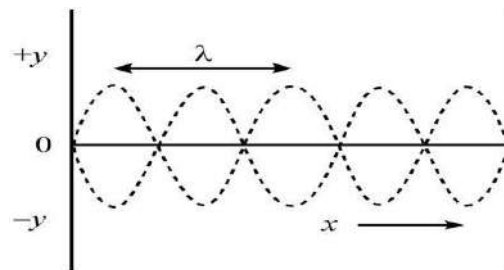

Figure 2.2: Wave motion

Mathematical equation of wave motion is

$$f'(t) = A \sin 2\pi vt \quad (2)$$

Where A = constant define maximum amplitude

v = Vibration frequency

Placing the value of $f'(t)$ in equation (1) from equation (2)

$$y = f(x) A \sin 2\pi vt \quad (3)$$

Differentiating equation 3 w.r. t . t ,

$$\frac{\partial y}{\partial t} = f(x)A2\pi v \cos 2\pi vt \quad (4)$$

Differentiating again

$$\frac{\partial^2 y}{\partial t^2} = -f(x)4\pi^2 v^2 A \sin 2\pi vt \quad (5)$$

$$\frac{\partial^2 y}{\partial t^2} = -4\pi^2 v^2 f(x) f'(t) \quad (6)$$

Again differentiate equation (1) w. r. t. x ,

$$\frac{\partial y}{\partial x} = f'(t) \frac{\partial f(x)}{\partial x} \quad (7)$$

Differentiating again

$$\frac{\partial^2 y}{\partial x^2} = f'(t) \frac{\partial^2 f(x)}{\partial x^2} \quad (8)$$

Now place value of equation (8) and (6) in equation (1),

$$f'(t) \frac{\partial^2 f(x)}{\partial x^2} = \left(\frac{1}{v^2} \right) [-4\pi^2 v^2 f(x) f'(t)] \quad (9)$$

$$\frac{\partial^2 f(x)}{\partial x^2} = \frac{-4\pi^2 v^2}{v^2} f(x) \quad (10)$$

Equation (10) is time-independent. Since $c = v\lambda$ ($v = c/\lambda$)

So $v = v\lambda$.

$$\frac{\partial^2 f(x)}{\partial x^2} = \frac{-4\pi^2 v^2}{v^2 \lambda^2} f(x) \quad (11)$$

$$\frac{\partial^2 f(x)}{\partial x^2} = \frac{-4\pi^2}{\lambda^2} f(x) \quad (12)$$

Function $f(x)$ is changed by ψ .

$$\frac{\partial^2 \psi}{\partial x^2} = \frac{-4\pi^2}{\lambda^2} \psi \quad (13)$$

Also, $\lambda = h/mv$, then equation (13) becomes

$$\frac{\partial^2 \psi}{\partial x^2} = \frac{-4\pi^2 m^2 v^2}{h^2} \psi \quad (14)$$

$$\frac{\partial^2 \psi}{\partial x^2} + \frac{4\pi^2 m^2 v^2}{h^2} \psi = 0 \quad (15)$$

Total energy (E) is sum of Potential (V) and Kinetic energy

$$E = \frac{mv^2}{2} + V \quad (16)$$

$$mv^2 = 2(E - V) \quad (17)$$

Putting value of (17) in equation (15), we get

$$\frac{\partial^2 \psi}{\partial x^2} + \frac{8\pi^2 m}{h^2} (E - V) \psi = 0 \quad (18)$$

For three-dimension $\psi(x, y, z)$, and equation 18 written as

$$\frac{\partial^2 \psi}{\partial x^2} + \frac{\partial^2 \psi}{\partial y^2} + \frac{\partial^2 \psi}{\partial z^2} + \frac{8\pi^2 m}{h^2} (E - V) \psi = 0 \quad (19)$$

Equation 19 is second order differential equation known as Schrödinger Equation.

2.1.1 Significance of Ψ and Ψ^2

- $\Psi(\psi)$ is identified as a wave function which represent probability amplitude of electron wave and not have any physical significance. $\Psi(\psi)$ may be positive, negative and imaginary.

- The probability density or Ψ^2 determine the maximum probability of finding electron at specific location in an atom. Thus, if:
 - Since Ψ^2 is zero, there is very little possibility of detecting an electron there.
 - When Ψ^2 is high, than high chance of finding an electron for a long time. And if Ψ^2 is low, there is little chance of finding an electron for short time period.

The conditions for acceptability of wave function (Ψ) as follows.

1. It needed be continuous.
2. It needs to be finite.
3. It needs to be single valued.
4. It needs to be normalized that means probability of electron finding at all over space is $-\infty$ to $+\infty$ must be equal to one.

$$\int_{-\infty}^{+\infty} \Psi^2 dx, dy, dz = 1$$

2.2 Radial wave function and angular wave functions

The wave equation is simple to solve if the Cartesian coordinates (x, y, and z) are transformed into polar coordinates (r, θ , and ϕ). The relationship between two sets of coordinates is given as:

$$z = r \cos \theta$$

$$y = r \sin \theta \sin \phi$$

$$x = r \sin \theta \cos \phi$$

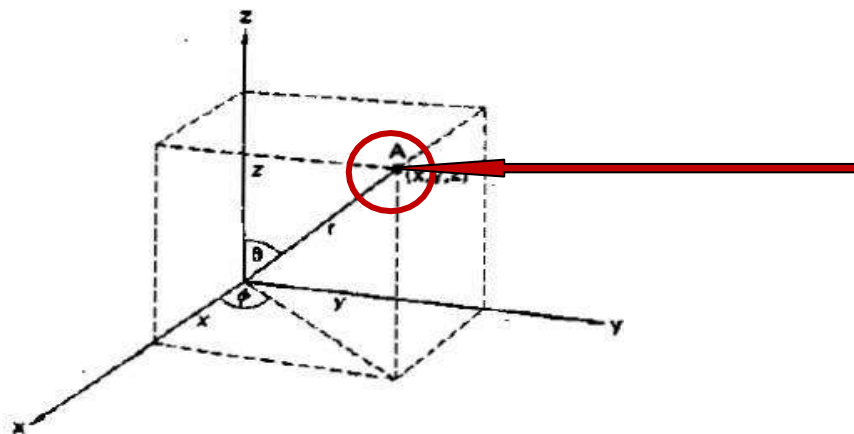

Fig. 2.3: Cartesian and polar coordinates

Schrodinger equation is written as:

$$\nabla^2 \psi + \frac{8\pi^2m}{\hbar^2} (E-V)\psi = 0$$

Changing the above equation to polar coordinate

$$\Psi = R(r) \Theta(\theta) \Phi(\phi)$$

$R(r)$ is function which depends on the distance from the nucleus and quantum numbers n and l .

$\Theta(\theta)$ is function of θ ; which depends on l and m quantum number

$\Phi(\phi)$ is function of ϕ , which depends only on m quantum number

Above equation can be written as:

$$\Psi = R(r) \Theta(\theta) \Phi(\phi)$$

This equation splits the wave function into two parts, which can be solved separately:

1. $R(r)$ the radial function, which depends on the quantum numbers n and l .
2. $\Theta(\theta) \Phi(\phi)$ the total angular wave function, which depends on the quantum numbers m and l .

2.2.1 Radial Wave Function

However, Radial function (R) is not having any physical importance, but R^2 signify the possibility of finding the electron in a small volume (dv) nearby point at which R is calculated. For a given price of r the range of tiny volumes is $4\pi r^2$, so the opportunity of the electron becoming at distance r from nucleus is $4\pi r^2 R^2$, this is known as the radial distribution characteristic.

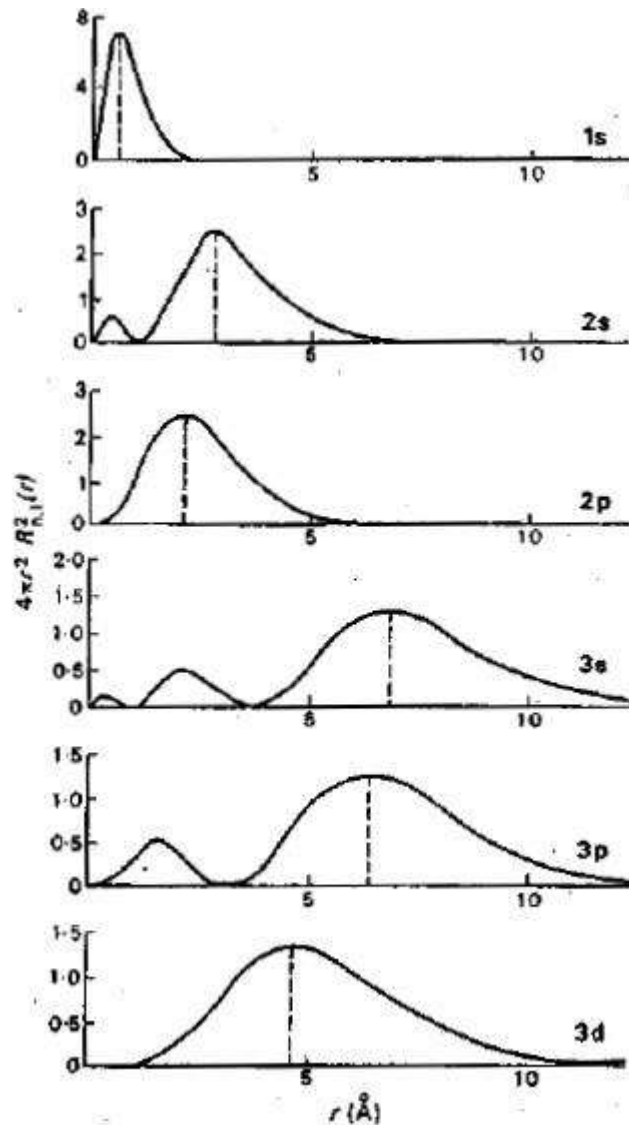

Fig 2.4: Radial distribution functions for various orbitals in hydrogen atom

- These figures demonstrate that the most likely distance rises noticeably as the principal quantum number rises, and that probability is zero near the nucleus.
- It is evident from comparing the charts for 2s and 2p or 3s, 3p, and 3d that the most likely radius somewhat reduces as the subsidiary quantum number rises.
- With the exception of the initial orbital (1s), all of the s orbitals have a structure like shell is made up coaxial layers of electron density, like an onion or hailstone.
- All orbitals have a shell structure, with the exception of first orbital of p (2p) and d (3d).

2.2.2 Angular wave function

The angular function A is independent of distance (r) from the nucleus and only depends on direction. As a result, A^2 represents the likelihood of discovering an electron at any distance to infinity in a specific direction, θ, ϕ from the nucleus.

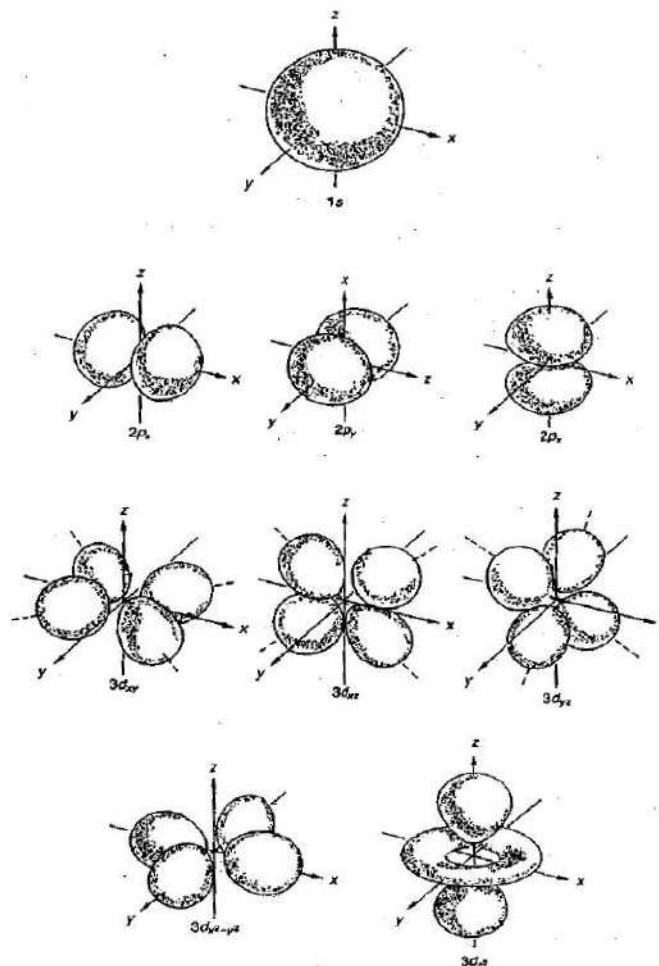

Fig 2.5: Angular distribution functions for various orbitals

Diagram presents angular portion of wave function, not entire wave function, ψ . The contributions from the angular and radial functions combine to form total wave function.

$$\Psi = R(r)A(\theta, \phi)$$

Thus, over all probability of finding an electron is

$$\Psi^2 = R^2(r)A^2(\theta, \phi)$$

When both radial and angular wave functions are combined, polar diagrams are utilized.

Since it is difficult to have pictorial representations of the angular wave function, boundary surface diagrams are made to depict the solid shape of the orbital holding 90% of electron

density. The angular wave function can have a value of + or -. Additionally within a particular orbital, the sign of wave function may alter which shown by the presence of a node.

Angular and Radial Nodes

Total number of nodes = $n-1$

Number of angular nodes = l

Number of radial nodes = $n-1-l$

- There are two types of nodes: radial and angular.
- The number of angular nodes depends on the Azimuthal quantum number.

2.2.3 Angular nodes for 2p and 3d orbitals

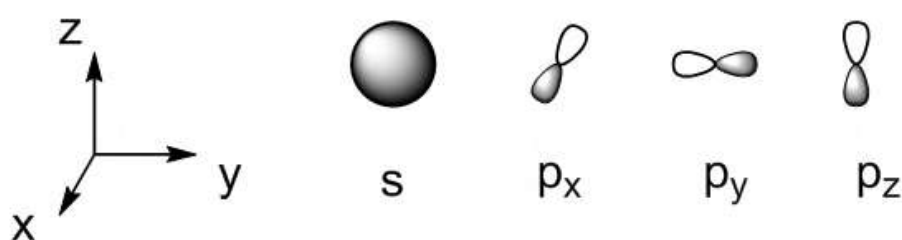

Fig. 2.6 The angular nodes for the 2p orbitals

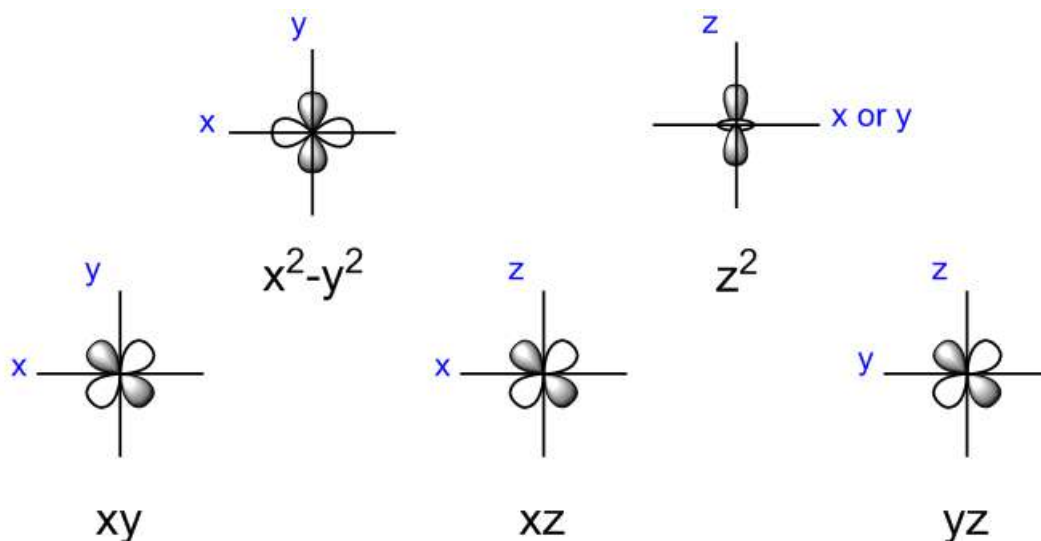
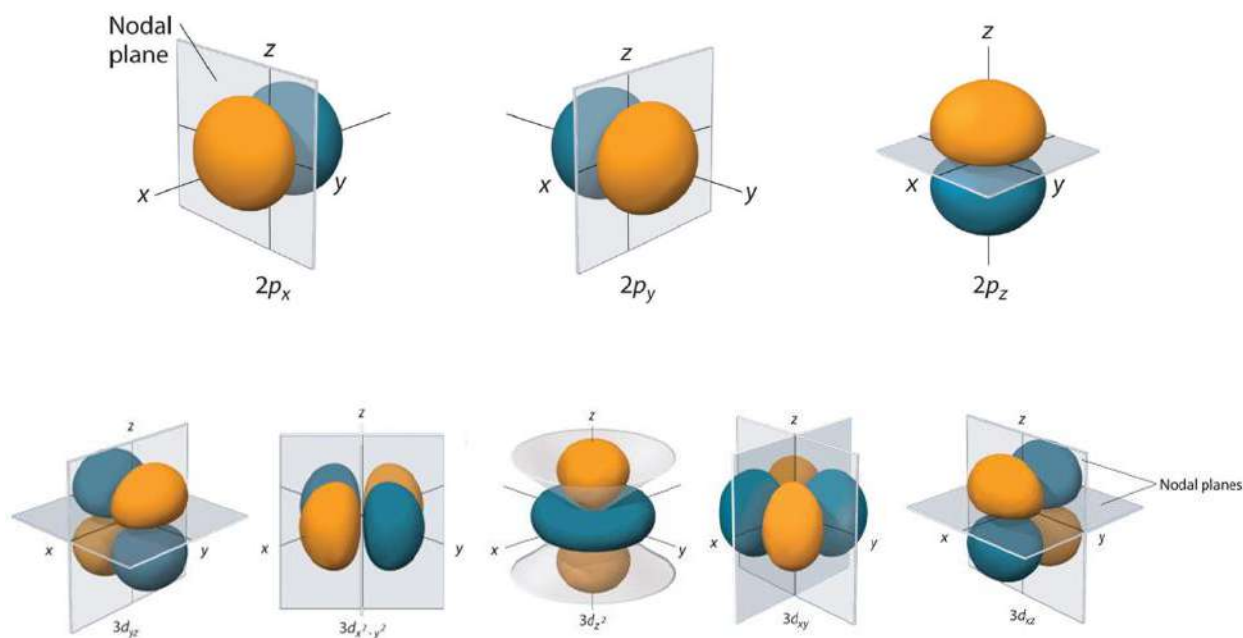

Fig. 2.7 The angular nodes for the 3d orbitals

2.2.4 Nodes in p and d orbitals:

- Where the probability of finding electron is zero known as Nodes.
- p and d orbitals have planar nodes between lobes of electron densities.



Summary

The time-independent Schrödinger equation is a partial differential equation in quantum mechanics. The symbol ψ represents the wave function. Atomic orbitals are described by hydrogenic wave functions, which have radial and angular components. The radial part depends on the distance from the nucleus, while the angular part depends on the direction in space. Graphical representations show the variation of these components for different orbitals.

Keywords

Schrödinger Equation: Equation describing stationary states of quantum systems

Wave Function: wave function in quantum mechanics, denoted as Ψ (psi), describes the state of a physical system and contains information about its properties.

Radial and Angular Nodes:

Radial nodes are points where probability density is zero along radial direction. Angular nodes are regions of zero probability density in certain directions.

MCQs

Q1. Which branch of physics shows the nature of particles at the atomic and subatomic levels?

- a) Classical mechanics
- b) Quantum mechanics
- c) Relativistic mechanics
- d) Thermodynamics

Answer: B

Q2. What does the time-independent Schrödinger equation describe?

- a) Evolution of wave function with time
- b) Wave function of stationary states
- c) Behavior of particles in a magnetic field
- d) Interaction of light with matter

Answer: B

Q3. In the Schrödinger equation, what does the symbol Ψ represent?

- a) Particle's position
- b) Particle's momentum
- c) Wave function
- d) Probability density

Answer: C

Q4. What does $|\Psi|^2$ represent in quantum mechanics?

- a) Position of the particle
- b) Momentum
- c) Probability density
- d) Particle Kinetic energy

Answer: C

Q5. Schrödinger equation for the H atom describes the behaviour of:

- a) Protons
- b) Electrons
- c) Neutrons

d) Photons

Answer: b) Electrons

Self-assessment

1. Explain the significance of Ψ in quantum mechanics.
2. Describe the meaning of the term "time-independent" in the Schrödinger equation.
3. What does the term "stationary states" refer to in the context of the Schrödinger equation?
4. Define radial and angular nodes in the context of atomic orbitals and explain their significance.

UNIT – 3

Significance of Quantum Numbers

Objectives

- Understand the significance of quantum numbers in describing the quantum states of particles within an atom
- Learn about the shapes atomic orbitals and the concept of nodal planes.
- Familiarize with the rules for filling electrons and the electronic configurations
- Recognize the stability associated with half-filled and completely filled orbitals

3.1 Quantum Number

Quantum numbers is used to determine shape, size and orientation of orbital in space.

Quantum numbers are four types:

- ✓ Principal quantum number(n)
- ✓ Azimuthal quantum number(l)
- ✓ Magnetic quantum number(ml)
- ✓ Spin quantum number(ms)

3.1.1 Principal quantum number (n)

1. Proposed by Bohr for the explanation of the hydrogen atomic spectrum and used symbol n for it
2. It is used to calculate average distance between neutron and electron.
3. The value of n determines the energy of an orbital or shell.
4. n has integer values 1,2,3,.. with symbols K,L,M,N_ __
5. Maximum number of electrons in a shell is calculated by $2n^2$.
6. With the increase in value of n, value of energy also increases.

3.1.2 Azimuthal quantum number (l)

1. Azimuthal quantum number or angular quantum number is given by Sommer field and denoted by 'l'.
2. It denotes to the sub-shells in the atom. The value of l depends on the value of principal quantum number 'n'.

3. It tells about the shape of sub shells. The value of sub-shells is in between 0 to n-1.
4. It also expresses the energies of sub shells $s < p < d < f$ (increasing energy). E.g. $l = 0$ (s)--- spherical , $l = 1$ (p)--- dumbbell, $l = 2$ (d)--- double dumbbell, $l=3$ (f) – complexes.
5. The maximum number of electrons in subshell calculated by $2(2l+1)s$ --- 2 electrons, p --- 6 electrons, d --- 10 electrons, f--- 14 electrons

3.1.3 Magnetic quantum number (l)

1. Magnetic quantum number was proposed by Lande for the explanation of the Zeeman and Stark effects.
2. Splitting of the spectral lines in strong magnetic field is known as Zeeman effect and in strong electric field it is called Stark effect.
3. It is denoted by 'm' and describes the orientation of orbitals (Sub sub shell)
4. The value of m is depends upon the value of l and is equal to the (2l+1) and can have values from -l_ _ _ 0 _ _ _ +l.
5. Note that given value of 'n', the total value of 'm' equals to $2n^2$ and for 'l' total value of 'm' is (2l+1).
6. Maximum number of electron in any sub shell is 2.

Principal quantum number (n)	Azimuthal quantum number (l)	Magnetic quantum number (m)
n = 1	l = 0	m = 0 (s)
n = 2	l = 0,1	m = -1,0,+1 (px, py, pz)
n = 3	l = 0,1,2	m = -2,-1,0,+1,+2 (d _{xy} , d _{yz} , d _{zx} , d _{x²-y²} , d _{z²})
n = 4	l = 0,1,2,3	m = -3, -2,-1,0,+1,+2,+3

3.1.4 Spin quantum number

1. Goudsmit and Uhlenbeck proposed to explain double line spectra of alkali metal and denoted by symbol s .
2. Denotes spin of electron on its own axis and on the basis of rotation its two values are possible $+1/2$ and $-1/2$.
3. When rotates clockwise spin is denoted by $+1/2$ or symbol of upward arrow (\uparrow) and for anti-clockwise denotes by $-1/2$ or symbol of downwards arrow (\downarrow).

3.2 Significance of Quantum Numbers

Quantum number	Possible values	Significance
Principal quantum number (n)	1,2,3,4,_____	Size
Azimuthal quantum number (l)	0 to n-1	shape
Magnetic quantum number (m)	-l ___ 0 ___ +l	orientation
Spin quantum number (s)	$+1/2$ or $-1/2$	spin

3.2 Shapes of Atomic Orbitals:

In 3-D space around nucleus of an atom where the possibility of finding electron is the maximum is called an atomic orbital. They have different type of shapes.

- **s orbital** - spherical shape
- **p orbital's** -dumbbell shape,
- **d orbital's** –double dumbbell shape
- **f orbital's** – Complex shape

3.2.1 s –Orbital

1. s-orbitals have spherical shape.

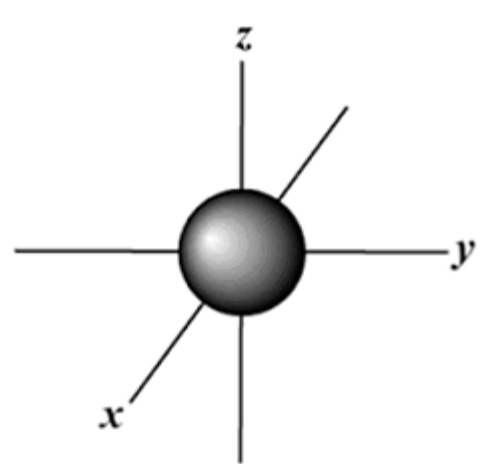

Figure 3.1 s-Orbital

2. It does not have any directional property.
3. S-orbitals have equal value probability of finding an electron at equal distances from the nucleus due to symmetry of s-orbital.
4. As the value of n increases size of s-orbital increases, so $4s > 3s > 2s > 1s$.

3.2.2 p Orbitals

1. There are two lobes in p orbitals. They are present on both side of the plane which passes through the nucleus of the atom.
2. p orbital's have shape of dumbbell in which two opposite side lobes are separated by the nodal plane
3. All three p orbitals show similarity in their shape, size and energy but different in the orientation.
4. p-orbital has directional properties.
5. As the quantum number increases, energy and size of p orbital's also increases r i.e. $4p > 3p > 2p$.

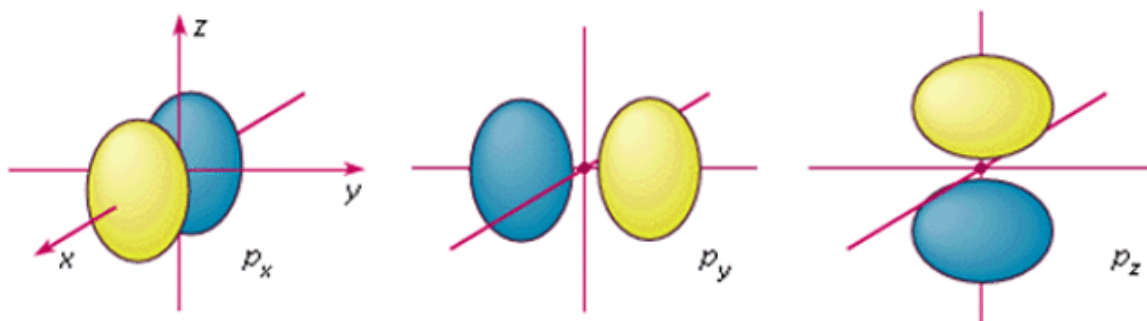

Figure 3.2 p Orbital

3.2.3 d-Orbitals

1. The value of m quantum number for d orbitals is (-2, -1, 0, 1, 2) so there are five d orbital's.
2. The five d orbitals are further separated in to axial (their lobes are on the axis) and non-axial orbitals (their lobes are between the axis)
3. The designations of the d orbitals are d_{xy} , d_{yz} , d_{xz} , $d_{x^2-y^2}$ and d_z^2 .
4. Shape of the d orbitals is double dumbbell.
5. Each of the 'd' orbital similar in shape, size and energy.

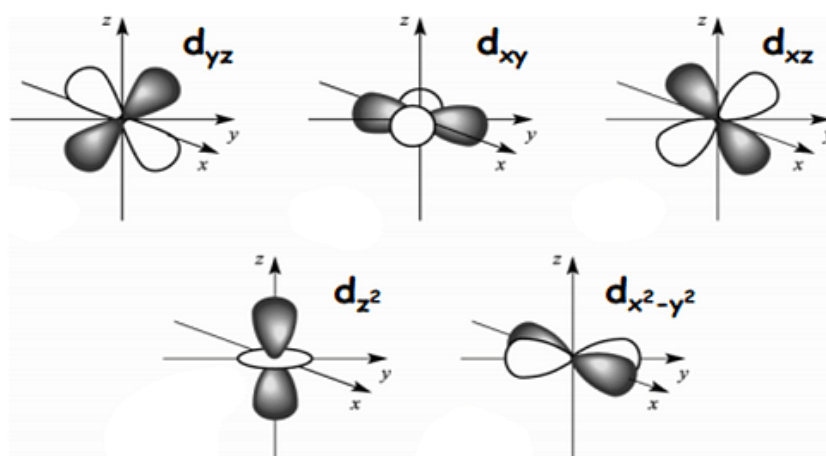

Figure 3.3 shape of d Orbital

3.2.4 f-Orbitals

1. The f orbital's have magnetic quantum numbers m_l (-3, -2, -1, 0, 1, 2, 3).
2. They also have the secondary quantum number $l = 3$.
3. The f orbitals are designated by $f_{y(3x^2-y^2)}$, $f_{z(x^2-y^2)}$, f_{xyz} , f_{yz^2} , $f_{x(3x^2-y^2)}$, f_{xz^2} and f_z^3 .
4. Each of the f orbital is multi-lobed and complex in shape with several nodal points.
7. The f orbitals have three nodal planes with the atomic nucleus at the centre and complex shapes.

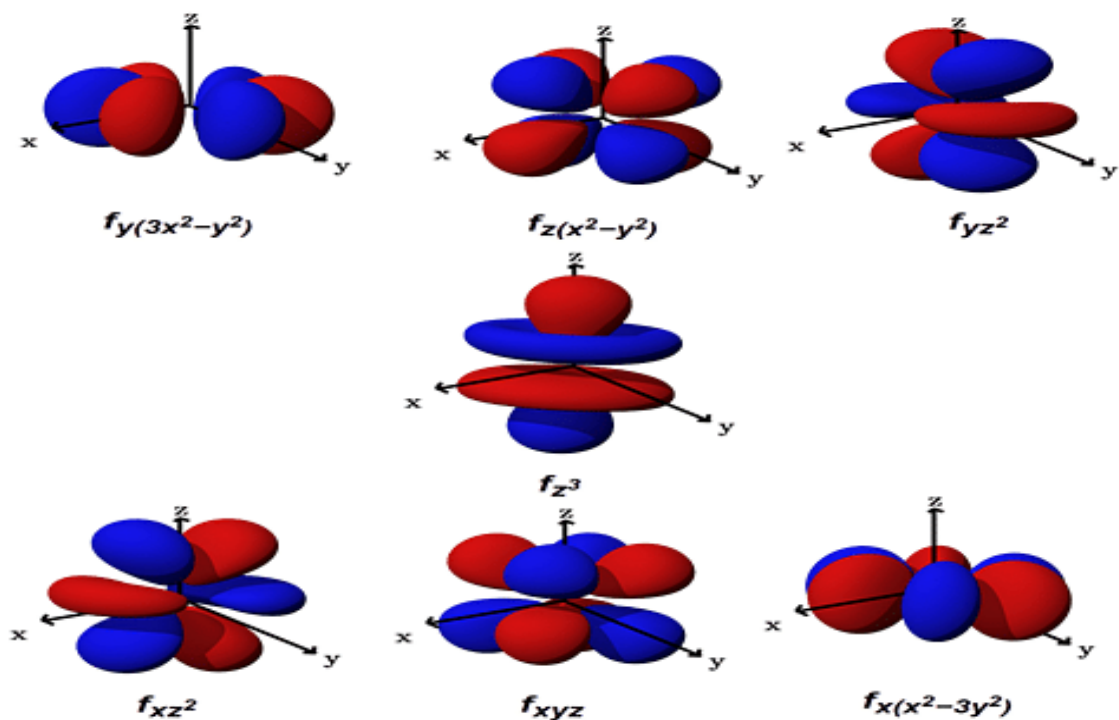

Figure 3.4 shape of d-orbital

3.3 Rules for filling of the electrons in various orbitals

Electronic configuration -Distribution of electrons in various orbitals of atom is called as electronic configuration. Electrons filled in orbitals of an element under a set of rules.

General Rules for Filling of the Electrons

- Aufbau's principle
- Pauli's exclusion principle
- Hund's rule for maximum multiplicity

3.3.1 Aufbau's principle

- Aufbau is a German word, meaning 'building up'. And it stated that "In the ground state, the atomic orbitals are filled in order of increasing energies. i.e. in the ground state the electrons first fill in the lowest energy orbitals available".
- Energy of orbital is calculated by the $(n+1)$ rule.
 - (a) The orbital have Lower value of $n + 1$ has less value of energy electron filled up first.
 - (b) Two orbitals with same value of $(n+1)$, then electron fill in first which have lower value of "n".

Order of filling the electrons in orbitals is:

$1s < 2s < 2p < 3s < 3p < 4s < 3d < 4p < 5s < 4d < 5p < 6s < 4f < 5d < 6p < 7s < 5f < 6d < 7p < 6f \dots$

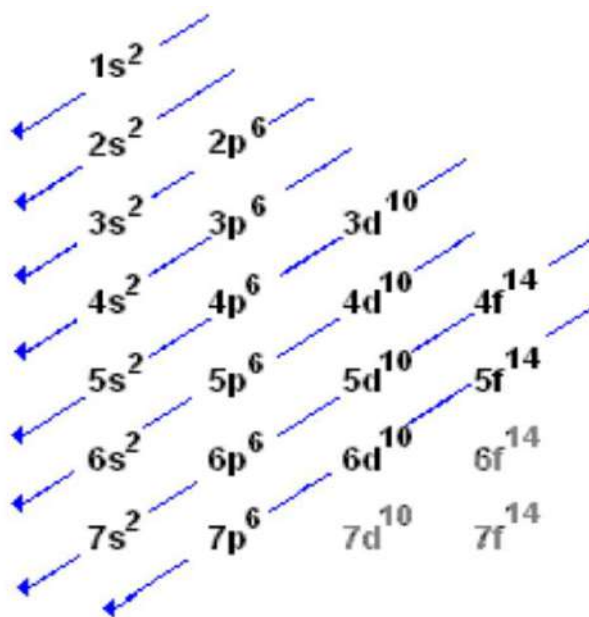
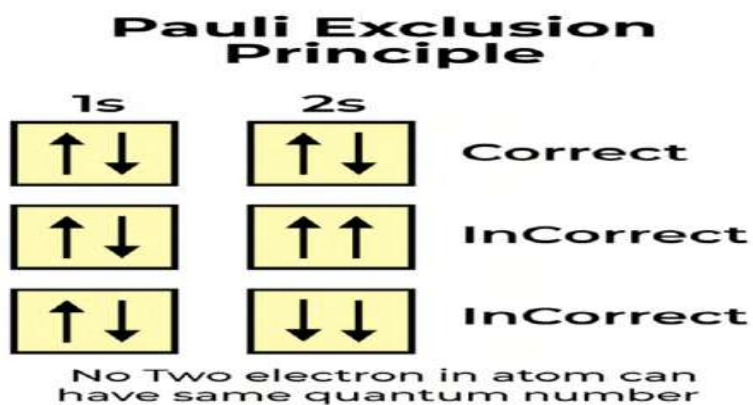

Figure 3.5 The order of filling of the electrons

3.3.2 Pauli's Exclusion Principle

- The value of four quantum numbers n , l , m and s is not similar for two electrons.
- In every atom three quantum numbers are similar for two electrons but fourth quantum number is must be different.
- Two electrons with opposite spin accommodate in an orbital.



3.3.3 Hund's rule of maximum multiplicity

- This rule is useful to filling up the degenerate orbital's of the same sub-shell.

- The rule states “Electron filling will not take place in orbitals of same energy until all the available orbitals of a given subshell contain one electron each with parallel spin”.

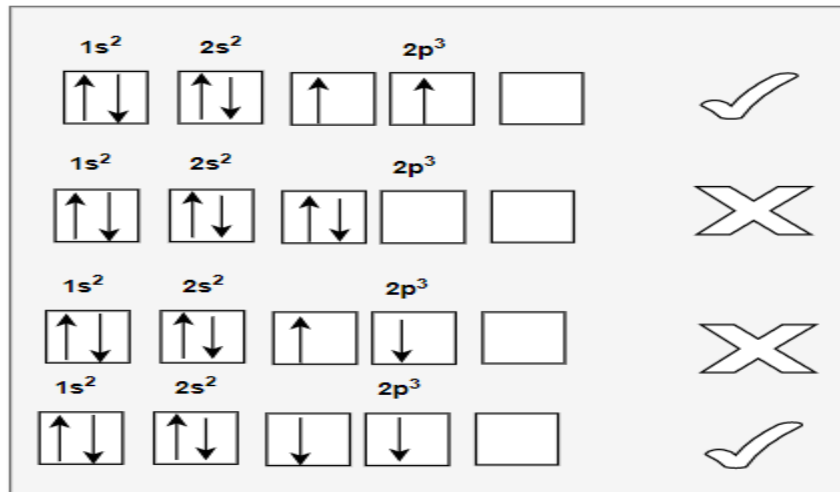

- The rule state that first single electrons with parallel spin are filled in the orbital after that pairing of electrons done by the filling of opposite spin electrons.
- Half-filled and fully filled orbitals which have configuration p^3 , p^6 , d^5 , d^{10} , f^7 & f^{14} are more stable.

Examples of Exceptional electronic configurations:

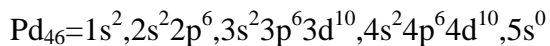
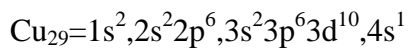
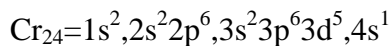

3.4 Stability of half-filled and completely filled orbital's

Completely filled and Half-filled sub-shell consist extra stability than partially filled. The reasons for this are as below:

1. Symmetry of orbitals-

- It is important symmetry relates to stability. So that electrons shift from one orbital to another have differs slightly in energy becomes symmetrical electronic configuration and more stable.
- Electronic configuration p^3 , d^5 , and f^7 are more stable in compare to their near ones.

2. Exchange energy –

- Electron have same energy in same sub shell but it can exchange its position with various sub shells.
- Value of exchange energy in half filled and completely filled orbitals is maximum and loss of orbital energy is greater because of transfer of electron from higher sub shell to a lower.
- In s-orbital due to spherical shape in all the direction electric charge is uniformly distributed. P-orbitals p_x , p_y , and p_z are symmetrical in x, y, and z-axis respectively.

Examples of elements those are symmetrically full-filled or half-filled:

- Chromium : $1s^2 2s^2 2p^6 3s^2 3p^6 3d^5 4s^1$
- Copper : $1s^2 2s^2 2p^6 3s^2 3p^6 3d^{10} 4s^1$

Summary

The significance of quantum numbers lies in their ability to describe the unique quantum states of particles within an atom. Orbital angular momentum, determined by the quantum numbers l and m , reflects the spatial orientation and shape of atomic orbitals. Shapes of s, p, and d orbitals are characterized by their nodal patterns, which indicate regions of zero probability density for finding electrons.

The discovery of spin introduced the concept of intrinsic angular momentum possessed by electrons, leading to the introduction of the spin quantum number (s) and magnetic spin quantum number (m_s). These quantum numbers describe the orientation and magnetic behavior of electron spin within an orbital.

Rules governing the filling of electrons in orbitals. Stability is observed in atoms with half-filled or completely filled orbitals due to their symmetrical and low-energy configurations.

Understanding these concepts provides a foundational understanding of atomic structure and electron behavior, crucial for interpreting chemical properties and interactions.

Keywords

Quantum numbers: Quantum numbers describe the unique quantum states of particles within an atom.

Atomic orbitals: Geometric configurations of electron probability distributions around the nucleus.

Nodal Plane: Regions of zero electron probability in atomic orbitals

Electronic configurations: Arrangement of electrons in different energy levels and orbitals within an atom.

MCQs

1. What do quantum numbers describe?
 - a) The mass of an electron
 - b) The unique quantum states of particles within an atom
 - c) The speed of an electron
 - d) The charge of an electron

Answer: B

2. Orientation of an atomic orbital in space is represented by
 - a) Principal quantum number (n)
 - b) Azimuthal quantum number (l)
 - c) Magnetic quantum number (m)
 - d) Spin quantum number (s)

Answer: B

3. Shape of a p atomic orbital is
 - a) Spherical
 - b) Dumbbell-shaped
 - c) Double dumbbell-shaped
 - d) Cloverleaf-shaped

Answer: B

4. What are nodal planes in atomic orbitals?
 - a) Regions of high electron probability density
 - b) Regions of low electron probability density
 - c) Regions where electron spin is defined
 - d) Regions where electron angular momentum is defined

Answer: B

Self-assessment

1. Describe the significance of quantum numbers in atomic physics.
2. Explain the concept of angular momentum
3. Provide the shapes of orbitals and explain how they are determined.
4. Briefly outline the rules for filling electrons in various orbitals according to the Aufbau principle, Pauli exclusion principle, and Hund's rule.
5. Discuss the electronic configurations of atoms and how they are represented using quantum numbers

UNIT – 4

Ionic Bonding

Objectives

- Understand the characteristics of ionic bond.
- Explore the enthalpy considerations involved in ionic bond.
- Learn about lattice and solvation energy and their significance in the stability and solubility of ionic compounds.

4.1 Ionic Bond

4.1.1 Definition

Ionic bond can be defined as a Columbic force of attraction between oppositely charged ions. It is a type of chemical linkage.

- The ionic bond is an important category of chemical bonds occurs between chemical entities to provide a stable form.
- Ionic bond is created by the transfer of electrons among the two atoms, Due to which charged species are formed.
- Positive charge will be imposed on the atom that loses electrons and will be called as cations while negative charge will be imposed on the atom that gains electrons and will be called as anions.
- Due to their electronic configuration, most of the metal ions behave as cations and nonmetal behave as anions.
- The compound which contains ionic bond is called ionic compounds. This is formed by forces of attraction and repulsion in between dissimilar charges and same charges respectively.
- Neutralization reactions of acid and base also involve ionic bond which results in the formation of salts.
- All ionic compounds do have some extent of covalent bonding and hence an ideal ionic bonding doesn't exist.
- If percentage of ionic nature of the bond exceeds percentage of covalent character, the term ionic bond will be used.

- Electronic configuration of atoms decides the electrovalency and it determines the strength of the ionic bond.

- Ionic bonds are also known electrovalent bonds.

4.1.2 Necessary conditions for Ionic Bond formation

- The ions of two elements involved in the ionic bond formation should have opposite charges. Commonly, metals and non-metals form ionic bonds.
- Out of the two atoms linked for formation of ionic bond, one must have a less value of ionization enthalpy so it can give up electrons easily to form +ve charged ions i.e. cations and another atom must have more electron gain enthalpy so that easily it gains electrons and forms negatively charged ions i.e. anions.
- The electronegativity difference between two atoms involved in ionic bond formation must be greater than 1.7.
- For the stability of ionic compound lattice enthalpy must be high.
- Ionic bond character should be more than that of covalent bond.

4.1.3 Characteristic of Ionic compounds

1. State

- a. Ionic compounds usually found in solid-state at normal condition of temperature.
- b. Owing to high lattice enthalpy of ionic compounds they show high stability in solid-state.

2. Solubility

- a. Ionic compounds are miscible in polar solvent like water and are immiscible in non-polar solvents like benzene.
- b. Due to the breakage of ionic bonds they dissolve in polar solvents like water. Hydration of ions due to ionic dipole interaction results in solubility of ionic compounds.

3. Boiling point and melting point

Due to strong attractive forces in the ionic compounds, these are having high melting point and boiling point and they need a huge quantity of heat to overcome these forces.

4. Density

Due to strong attractive forces between the oppositely charged ions they are prearranged in a close-packed crystal form, which results in high denser compounds.

5. Brittleness

- a. The regular and orderly array of the ions in crystal lattice results in increase their brittleness.
- b. On beating of these compounds the ions comes close to each other resulting in restoration of repulsive forces, which increases brittleness of the compound.

6. Non-directional

- a. Since the attractive forces between oppositely charged ions operate equal in every directions, so ionic bonds show non-directional property.
- b. Due to their non-directional nature, isomerism is not shown by them.

7. Electrical conductivity

- a. They get dissociated into charged ions in aqueous and molten state. Theses ions carry electrical charges which makes them conductor of electricity.
- b. In the solid-state the ions cannot move freely so doesn't conductor of electricity.

4.1.4 Formation of Ionic Bond

- Ionic bonds are created between only those atoms which are having electronegativity difference of 1.7 or more.
- When these atoms come close to each other, the difference in electronegativities results in uneven electrons sharing so that one atom loses electrons while the other gains electrons.

- Redox reaction is involved in ionic bond formation which occurs when the atom have less ionization enthalpy gives electrons to get a stable electronic configuration, and formation of cations occurs.
- The atom of another element with high electron gain enthalpy receive electron from the other atom to become stable. It results in the formation of anions.
- Electrovalency of atoms determines the strength of ionic bonds which depends on the bonds formed in order to attain noble gas configuration.
- When ionic bonds is formed specific ratio is found between negative and positive because ionic compounds follows stoichiometry.

4.1.5 Ionic Bonds Examples

1. Ionic bond in NaCl

- Ionic bond in NaCl is present between the Na^+ metal ion and Cl^- non-metal ion.
- Sodium atom configuration is $1s^2 2s^2 2p^6 3s^1$, it shows Na has one valence electron.
- To achieve stable electronic configuration atom tends to lose one electron.
- Chlorine atoms configuration IS $1s^1 2s^2 2p^5$ and it accepts an electron to get a stable electronic configuration.
- Sodium atom will lose an electron to form sodium ion and chlorine atom take electron to form a chloride ion during the formation of the ionic bond in NaCl.

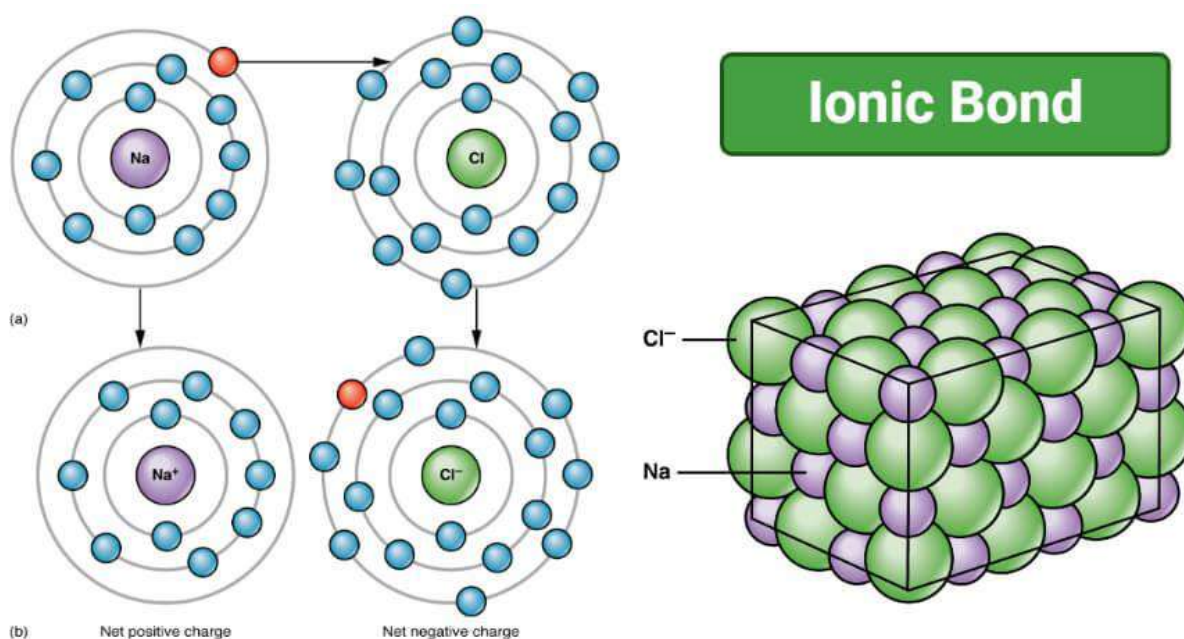

Figure 4.1: Ionic Bond in NaCl

2. Ionic bond in MgO

- MgO also involves ionic bond between the magnesium and oxygen atoms. In this electrons transfers from magnesium to oxygen.
- Two electrons in its valence shell of magnesium atom results in little ionization enthalpy. Whereas oxygen atom wants two electrons more to gain stable electronic configuration.
- Since the electrons transfer from magnesium to oxygen atom ionic bond formation occur.

4.1.6 Uses of Ionic Bonds

- Ionic bond stabilizes tertiary and quaternary structures of proteins to maintain its shape.
- Ionic bonds are used in formation of chromosomes.
- Ionic bonds maintain cell potential, Muscle contraction and cell signaling

Summary

Ionic bonding is a type of chemical bonding that occurs between ions of opposite charges. In this bond, one atom transfers one or more electrons to another atom, resulting in the formation of positively charged cations and negatively charged anions. These ions are held together by strong electrostatic forces of attraction, forming ionic compounds.. Higher lattice energy indicates stronger ionic bonds and greater stability of the ionic compound. Understanding both lattice energy and solvation energy is essential for predicting the stability and solubility of ionic compounds. Higher lattice energy favors the formation of stable ionic solids, while favorable solvation energy promotes the dissolution of these solids in a solvent, leading to increased solubility.

Overall, the interplay between lattice energy and solvation energy governs the behavior of ionic compounds, influencing their stability, solubility, and various properties in different chemical environments.

Keywords

Ionic Bond: Bonding formed by transfer of electrons between atoms

Lattice energy: Energy required dissociating ions in an ionic bond to an infinitely separated state.

Solvation energy: Energy released when ions in a solid are surrounded by solvent molecules in solution.

MCQs

1. What is the primary characteristic of ionic bonding?

- a) Sharing of electrons
- b) Formation of covalent bonds
- c) Transfer of electrons
- d) Absence of electrostatic forces

Answer: C

2. Melting points of Ionic bonds are.....

- a) High
- b) Low
- c) Moderate
- d) None of these

Answer: A

3. Solvation energy is important in the context of:

- a) Increasing ionic compound stability
- b) Decreasing ionic compound solubility
- c) Facilitating the dissolution of ionic compounds
- d) Strengthening the ionic bonds

Answer: C

4. What is the Importance of lattice energy in calculating the stability of ionic compounds?

- a) Higher lattice energy leads to decreased stability
- b) Lower lattice energy leads to increased stability
- c) Lattice energy has no effect on stability
- d) Lattice energy determines the color of ionic compounds

Answer: B

5. General characteristics of ionic bonding include:
- a) Formation of covalent bonds
 - b) Sharing of electrons equally
 - c) Formation of positively and negatively charged ions
 - d) Lack of electrostatic attraction between ions

Answer: C

Self-assessment

1. Define ionic bonding and describe its general characteristics.
2. What are the energy considerations involved in ionic bonding, and how do they influence the stability of ionic compounds?
3. Explain the lattice energy and its significance in determining the strength of ionic bonds.
4. Discuss solvation energy in the solubility of ionic compounds and how it affects their dissolution in a solvent.
5. How do the ionic compounds differ from those of covalent compounds, and what accounts for these differences?

UNIT – 5

Covalent Bonding

Objectives

- Understand the concept of covalent bonding within the framework of the Valence Bond (VB) approach.
- Explore the geometry of molecules using the VSEPR theory and hybridization.
- Examine the concept of resonance and its application in describing the electronic structure of various inorganic and organic compounds.
- Provide examples to illustrate the principles of covalent bonding, VSEPR theory, hybridization, and resonance in chemical structures.

5.1 Types of Bonding

Four main different types of bonding are as follows.

- Covalent bonding that formed by involvement of electrons among any two atoms.
- Hydrogen bonding is a weak bonding between hydrogen and electronegative atom mostly oxygen and nitrogen.
- Van der Waals is strength attracts neutral molecules due to their slight polar charges.
- Ionic bonds formed when two opposite charges ions of are involved

5.2 Covalent Bond

Two atoms that share an equal number of electrons form a covalent bond and this bond is formed by a pair of electrons known as a bonding pair or sharing pair. It is also known as molecular bonds. By accruing a total of eight electrons on their outer shell, the bonding pairs ensure the stability of this shell. Atoms having high ionisation energies are incapable to transfer their electrons while those with low ionization energy cannot accept electrons.

Examples of covalent bond formed sharing of electron within the same element are H_2 , Cl_2 , O_2 . Examples of covalent bond formed sharing of electron within the different elements CH_4 , H_2O , NH_3 .

5.2.1 Covalent Bonding in Carbon Atom

On the basis of electronic configuration and to achieve stability, carbons either gain or lose four electrons from their outermost shell. Since it cannot gain or lose electrons to become a negative and positive ion, respectively, both situations will disturb the stability of the carbon atom. Due to this reason carbon atom shares the required number of electrons and forms a covalent bond.

5.2.2 Properties of Covalent Bond

Certain properties of covalent bonds are:

- There are strong bonding between two atoms
- The energy of a covalent bond is usually ~ 80 kcal/mol.
- They resist the bonds' involuntary breaking.
- Atoms associated in covalent bonding have specific orientations to each other.
- Covalent bonded compounds have lower M.P, B.P, lower enthalpies of vaporization and fusion.
- They are poor conductors of electricity.
- These compounds are not soluble in water.

5.2.3 About Octet Rule

In outer most shell those atoms contain 8 electrons follow the octet rule and achieve stability, eg. Noble gases. It means that all other atoms those not having their own stability participate in bonding with other atoms to accomplish the 8 electrons in their valence shells.

This property of atoms to attain stability by having 8 electrons in their outer most shells is called a Chemical combination. This attitude that allows them to achieve stability with 8 electrons in outer shells called the Octet Rule.

5.2.4 Types of Covalent Bonds

Three types of covalent bond are:

- Single bond
- Double bond
- Triple Bond

Single Bonds

The two atoms in this case only share one electron pair and denoted by (-). However, this is the stable configuration but weaker than the other two types. For example, the HCl molecule formed by sharing of one valence electron of hydrogen and one electron of Chlorine atom having 7 valence electrons.

Double Bonds

The double bond is denoted as (=) and formed by two pair of electron sharing between the involved atoms. Covalent bond with double bond is less stable than single bond.

Example 1: CO₂. In this molecule carbon atom contribute two electrons to each oxygen and each oxygen contribute two electrons to carbon atom. And form two double bond between carbon and oxygen.

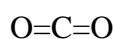

Example 2: Ethylene Molecule: In ethylene (C₂H₄), a double bond formed by sharing of two electrons by each carbon.

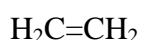

Triple Bond

The triple bond is denoted as (\equiv) and formed by three pair of electron sharing between the involved atoms. Covalent bond with triple bond is less stable than single bond.

Example- $\text{N} \equiv \text{N}$

Polar Covalent Bond

A polar covalent bond is made when the contributing of electrons is uneven due to the variance electronegativity of atoms. For the polarization covalent bond the difference in electronegativity should be 2-2.0. The atom with higher electronegativity pulls the paired electrons nearby than the other atom.

Nonpolar Covalent Bond

Nonpolar bonds are formed when the atoms that are bonding have the same electronegativity and net difference of electronegativity will always be zero.

For example, gaseous molecules such as H_2 , N_2 , O_2 etc.

5.2.5 Polarization of Covalent Bonds

It has been seen that the electron cloud approaches the higher electronegative atom in polar bonding and this cause generation of permanent dipole between the bonds. It is known as polarized covalent bonding. Here, atom which have high electro negativity contain negative charge while low electron negativity contain positive charge.

5.3 The Valence shell electron pair repulsion (VSEPR) theory

This theory is proposed by Sidgwick and Powell in 1940 and further developed and redefined by Nyholm and Gillespie (1957). This theory predict the structures of different polyatomic compounds. The basic principle of this theory is that lone pairs (lp) and bond pairs (bp) repel one another, thus they will adopt a geometry that puts them as far apart as feasible..



Figure 5.1: Structures for Molecules and Polyatomic Ions

On the basis of number of lp and bp present in atom VSEPR theory to predict geometry of ionic and polyatomic compounds

5.3.1 Postulates of VSEPR Theory

- (i) Shape of molecule depends on number of lp and bp pairs present in the central atom.
- (ii) lp and bp Pairs of electrons repel one another. Molecule contain only bp exist regular geometry .Order of repulsion of lone pair and bond pair are $lp-lp > lp-bp > bp-bp$
- (iii) Minimum repulsion and maximum distance should be there in between the pairs of electrons
- (iv) Most stable geometry has lowest value of energy.

Electron Groups	2	3	4	5	6
Geometry	Linear	Trigonal planar	Tetrahedral	Trigonal bipyramidal	Octahedral
Predicted Bond Angles	180°	120°	109.5°	90°, 120°	90°

Figure : 5.2 Geometries of Molecules

AX_mE_n Notation	AX ₂	AX ₂ E	AX ₃	AX ₃ E
Geometry	Linear X—A—X	Bent (V-shaped)	Trigonal planar	Trigonal pyramidal
Idealized Bond Angles	180°	<180°	120°	<120°
AX_mE_n Notation	AX ₄ E ₂	AX ₄	AX ₅	AX ₆
Geometry	Square planar	Tetrahedral	Trigonal bipyramidal	Octahedral
Idealized Bond Angles	90°	109.5°	90°, 120°	90°

Figure 5.3: Molecular Geometries for Species.

5.4 Valence Bond Theory

Valence Band Theory explains the electronic structure of materials, particularly semiconductors and insulators. It focuses on the behavior of electrons in the outermost energy band of atoms within a solid material, known as the valence band. In this theory, electrons in

the valence band are considered to be involved in bonding and are relatively tightly bound to the atoms.

Postulates of Valence bond theory:

1. The central metal atoms have empty hybrid orbitals equal to coordination number.
2. Vacant hybrid orbital of metal or ion overlap with sigma orbital of ligands.

Hybridization: The hybridization is process of mixing atomic orbitals of nearly same energy and different shape as a result equal number of new orbital's are form with equal energy and identical shape.

Coordination number of the central metal atom/ion	Type of hybridisation undergone by the central metal atom/ion	Geometry of the complex	Examples of complexes
2	$sp(4s, 4p_x)$	Linear or diagonal	$[\text{CuCl}_2]^-$, $[\text{Cu}(\text{NH}_3)_2]^+$ etc.
3	$sp^2(4s, 4p_x, 4p_y)$	Trigonal planar or equilateral triangular	$\left[\text{Cu}^+ \left(\text{S}=\text{C} \begin{array}{l} \diagup \text{NH}-\text{CH}_2 \\ \\ \diagdown \text{NH}-\text{CH}_2 \end{array} \right)_3 \right]^+$ $[\text{Cu}^+\text{Cl}(\text{tu})_2]^0$ (distorted trigonal planar) etc.
4	$dsp^2(3d_{x^2-y^2}, 4s, 4p_x, 4p_y)$	Square planar	$[\text{Ni}(\text{CN})_4]^{2-}$, $[\text{PdCl}_4]^{2-}$
4	$sp^2d(4s, 4p_x, 4p_y, 4d_{x^2-y^2})$	Square planar	$[\text{Cu}(\text{NH}_3)_4]^{2+}$ $[\text{Pt}(\text{NH}_3)_4]^{2+}$ etc.
4	$sp^3(4s, 4p_x, 4p_y, 4p_z)$	Tetrahedral	$[\text{NiCl}_4]^{2-}$, $[\text{Cu}(\text{CN})_4]^{3-}$, $\text{Ni}(\text{CO})_4$ etc.
5	$dsp^3(3d_z^2, 4s, 4p_x, 4p_y, 4p_z)$	Trigonal bipyramidal	$\text{Fe}(\text{CO})_5$, $[\text{CuCl}_5]^{3-}$, $[\text{Ni}^{2+}(\text{triars}) \text{Br}_2]^0$
5	$dsp^3(3d_{x^2-y^2}, 4s, 4p_x, 4p_y, 4p_z)$	Square pyramidal	$[\text{Co}^{2+}(\text{triars}) \text{I}_2]^0$, $[\text{Ni}(\text{CN})_5]^{3-}$ etc.
6	$d^2sp^3(3d_{x^2-y^2}, 3d_z^2, 4s, 4p_x, 4p_y, 4p_z)$	Inner-orbital octahedral	$[\text{Ti}(\text{H}_2\text{O})_6]^{3+}$, $[\text{Fe}(\text{CN})_6]^{3-}$ etc.
6	$sp^3d^2(4s, 4p_x, 4p_y, 4p_z, 4d_{x^2-y^2}, 4d_z^2)$	Outer-orbital octahedral	$[\text{Fe}^+(\text{NO}^+)(\text{H}_2\text{O})_5]^{2+}$, $[\text{CoF}_6]^{3-}$ etc.

Types of Hybridization

sp-Hybridization: It is the mixing of one s and one p orbital by which two new orbital of equal energies and identical shapes are produced, known as sp-hybrid orbitals.

They have linear shape and bond angle of 180° .

Examples: BeCl_2 , BeF_2

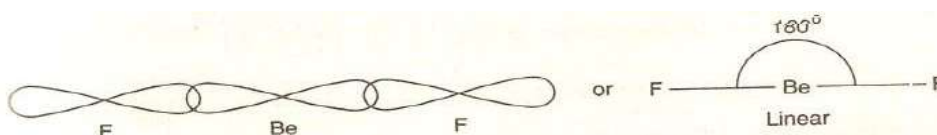
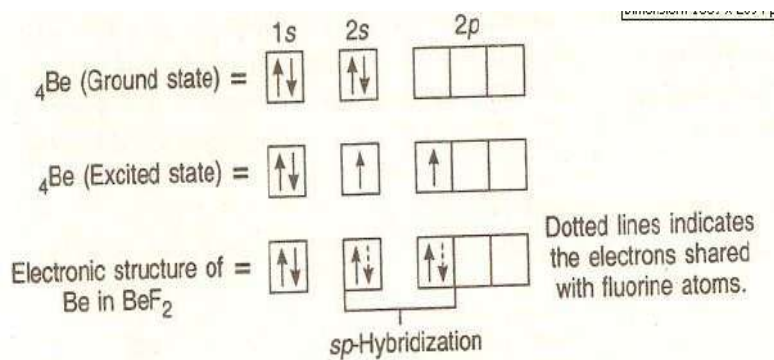

sp^2 -Hybridization: It is the mixing of one s and two p orbital by which three new orbital of equal energies and identical shapes are produced, known as sp^2 hybrid orbitals.

They have trigonal planar shape and bond angle of 120° .

Example: BF_3 , AlCl_3

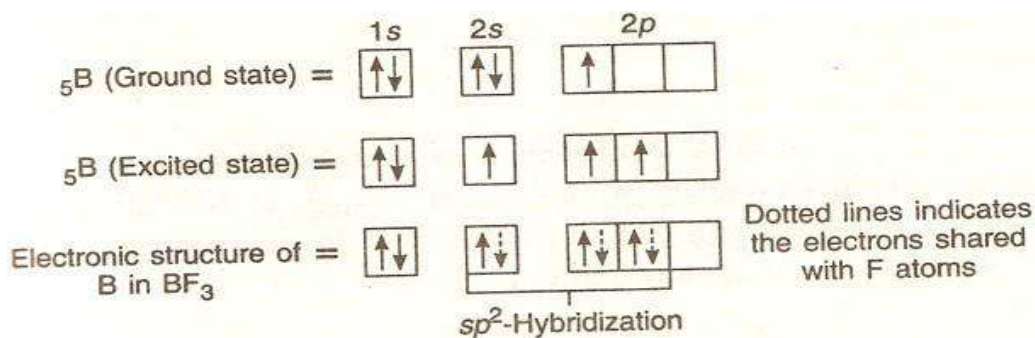
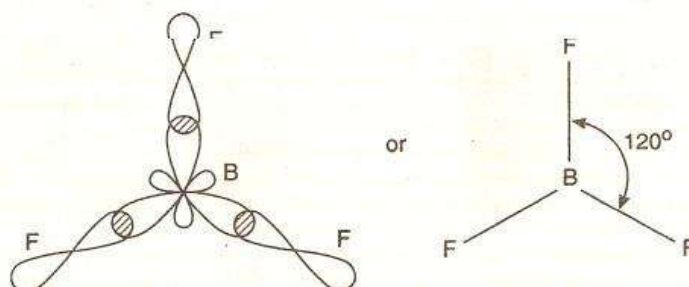

Sp³-Hybridization: It is the mixing of one s and three p orbital by which four new orbital of equal energies and identical shapes are produced, known as sp³ hybrid orbitals.

They have asymmetrical tetrahedral shape and bond angle of 109°28'.

Example CH₄, CCl₄, H₂O, NH₃

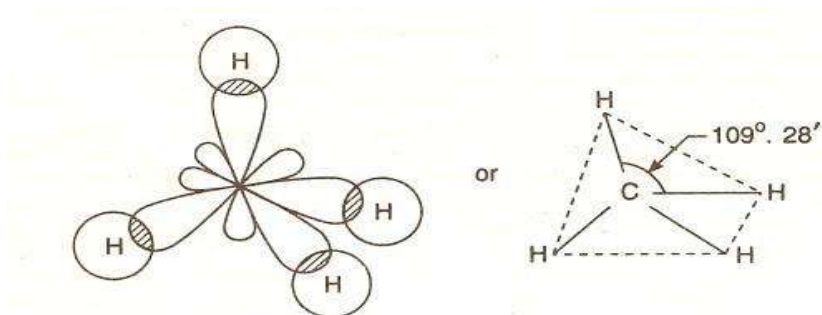

sp³d- Hybridization: It is the mixing of one s, three p and one d orbitals by which five new orbital of equal energies and identical shapes are produced, known as sp³d hybrid orbitals.

They have Trigonal bipyramidal with bond angle of 90° and 120°

Example: PCl₅

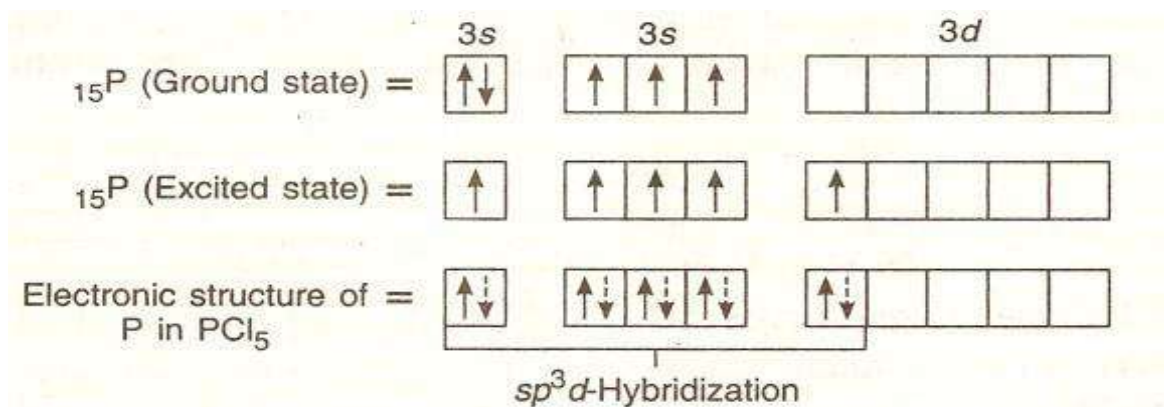

sp³d²- Hybridization: It is the mixing of one s, three p and two d orbitals by which six new orbital of equal energies and identical shapes are produced, known as sp³d² hybrid orbitals.

They have octahedral shape with bond angle of 90°.

Example: SF₆

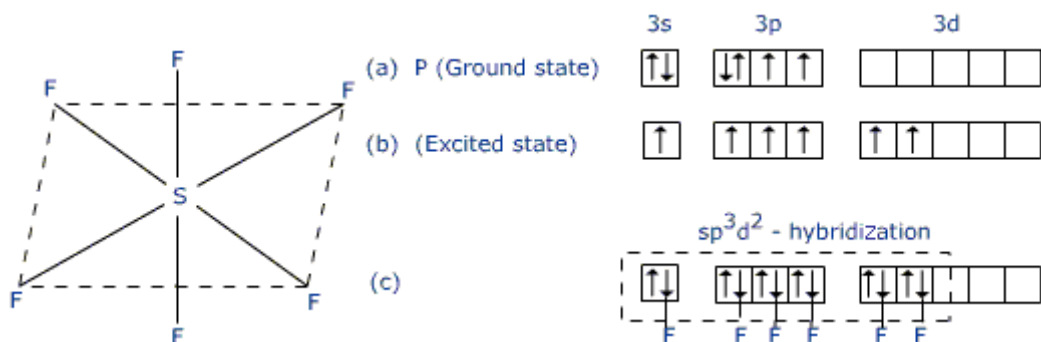

Summary

Covalent bonding is a type of chemical bonding where atoms share electron pairs. The Valence Bond (VB) approach provides a theoretical framework to understand covalent bonding by considering the overlap of atomic orbitals.

Using VSEPR theory, molecular geometries can be predicted. Hybridization further explains the observed geometries accommodate in bonding electron pairs. Resonance is a phenomenon observed in molecules and ions with delocalized electrons, where multiple Lewis structures, known as resonating structures, can be drawn to represent the actual electronic structure.

In summary, the VB approach, VSEPR theory, hybridization, and resonance provide valuable insights into the nature of covalent bonding and molecular structure, allowing chemists to predict and understand the behavior of diverse chemical compounds.

Keywords

Covalent bonding: Sharing of electron pairs between atoms

Valence Bonding: covalent bonding based on atomic orbital overlap.

Resonance: delocalization of electrons and multiple Lewis structures

MCQs

- Which theoretical framework explains covalent bonding by considering the overlap of atomic orbitals?
 - Molecular Orbital (MO) theory
 - Valence Bond (VB) approach
 - Hybridization theory

d) Lewis theory

Answer: B

2. Which theory predicts molecular geometries

a) Molecular Orbital (MO) theory

b) Valence Shell Electron Pair Repulsion (VSEPR) theory

c) Hybridization theory

d) Lewis theory

Answer: B

3. What is the molecular geometry of a molecule with three bp and no lp?

a) Linear

b) Trigonal planar

c) Tetrahedral

d) Square planar

Answer: B

4. Which molecular geometry has bond angles 109.5 and four bonded atoms around a central atom?

a) Linear

b) Trigonal planar

c) Tetrahedral

d) Square planar

Answer: C

5. What is the concept used to describe the phenomenon where multiple Lewis structures represent the actual electronic structure of a molecule?

a) Delocalization

b) Hybridization

c) Resonance

d) Polarization

Answer: C

Self-assessment

1. Explain the Valence Bond (VB) approach to covalent bonding.
2. Describe the concept of hybridization and its significance in determining molecular geometries.
3. Provide an example of a molecule with a linear molecular geometry and explain its arrangement.
4. Identify a molecule with an octahedral arrangement and explain its geometry and hybridization.

UNIT – 6

Molecular Orbital Theory

Objectives

- Understand the Molecular Orbital (MO) approach to chemical bonding.
- Learn the rules for LCAO method in the MO approach.
- Identify bonding and antibonding MOs and their characteristics .
- Explore nonbonding combinations of orbitals within the MO framework

6.1 Molecular Orbital Theory: Definition, Postulates of LCAO Method, Bond Order

In 1932 Hund and Mulliken developed the molecular orbital theory. According to this theory molecular orbitals are formed by the combination of atomic orbitals of atoms in molecule. These molecular orbitals may be bonding, antibonding, or nonbonding in nature.

6.1.1 Bonding molecular orbitals (MOs)

These molecular orbitals result from the constructive interference of atomic orbitals. Electrons in bonding molecular orbitals stabilize the molecule by lowering its overall energy.

6.1.2 Antibonding molecular orbitals

The MOs formed by out-of-phase addition of AOs called antibonding molecular orbitals. Their energy is higher than that of AOs. They also have node between the nuclei. The antibonding MOs represented by asterisk. Electrons in antibonding molecular orbitals destabilize the molecule by raising its overall energy. In the context of Molecular Orbital Theory (MOT), which describes the behaviour of electrons in molecules, Aufbau's principle applies to the filling of molecular orbitals. When molecular orbitals, are form electrons are filed in lower energy molecular orbitals before higher energy molecular orbitals.

6.1.3 Comparing MOs and AOs

1. Electrons within Atomic Orbitals (AOs) or Molecular Orbitals (MOs) are characterized by distinct wave functions.
2. Molecular orbitals, akin to atomic orbitals, exhibit diverse shapes and energies.

3. The adherence to Aufbau's principle, Hund's multiplicity rule, and Pauli's exclusion principle is imperative for sequential occupation of electrons in AOs or MOs.
4. Similar to atomic orbitals, molecular orbitals have the capacity to accommodate two electrons with opposite spins

6.1.4 Formation of Molecular Orbitals

Molecular orbitals (MOs) formation involves combination of atomic orbitals (AOs) of constituent atoms of molecule. This process is known as molecular orbital hybridization, results in formation of new molecular orbitals that extend over the entire molecule. When atoms come together to form a molecule, their atomic orbitals overlap. This overlap can be of various types, including sigma (σ) overlap, pi (π) overlap, and delta (δ) overlap, depending on the geometry and orientation of the atoms.

The overlapping atomic orbitals undergo a linear combination to form new molecular orbitals. This process involves adding or subtracting atomic orbitals wave functions, resulting in the creation of bonding, antibonding, and nonbonding molecular orbitals.

6.2 Linear Combination of Atomic Orbital (LCAO) Approximation

LCAO approximation is a mathematical technique used to blend atomic orbitals together to create molecular orbitals. This method allows us to represent the behavior of electrons in molecules by combining the wave functions of individual atomic orbitals. In simpler terms, it's like mixing different colors of paint to create new colors; in this case, we're mixing the properties of atomic orbitals to form new molecular orbitals. The wave function, which describes the wavelike behavior of electrons, provides a mathematical representation electron finding probability at a particular point in space within the molecule. So, LCAO essentially combines these wave functions to describe how electrons behave in molecules. Let us consider two atoms A and B which form molecule AB together.

Ψ_A and Ψ_B = wave function of A and B atomic orbitals.

Ψ_{MO} = wave function of AB molecular orbital

Formation of molecular orbitals as:

Bonding molecular orbitals: $\Psi_A + \Psi_B \rightarrow \Psi_{MO} = \Psi_{AB}$

Anti-bonding molecular orbitals: $\Psi_A - \Psi_B \rightarrow \Psi_{MO} = \Psi_{AB}$

6.2.1 Overlapping of Atomic Orbitals

a. S-S overlap

When s -atomic orbital of an atom combines with s-atomic orbital of another atom bonding (σ) and antibonding molecular orbitals(σ^*) are formed.

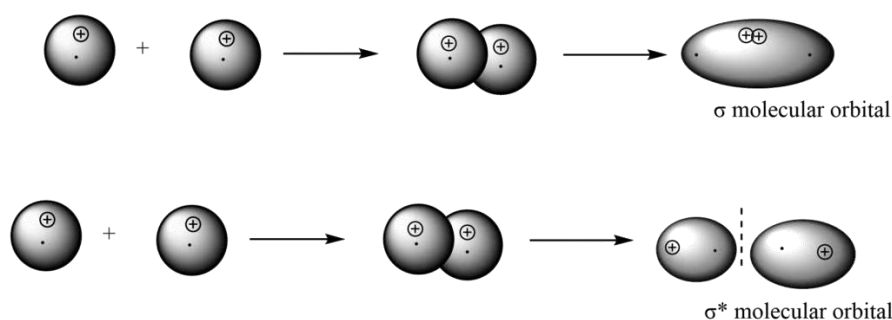

b. S – P_x overlap

When an s-orbital of one atom combines with the P_x-orbital of another atom, it forms bonding and antibonding molecular orbitals. In the bonding orbital, the wave functions add with the same sign, increasing electron density between nuclei. In the antibonding orbital, the wave functions subtract with opposite signs, resulting in nodes of zero electron density between nuclei.

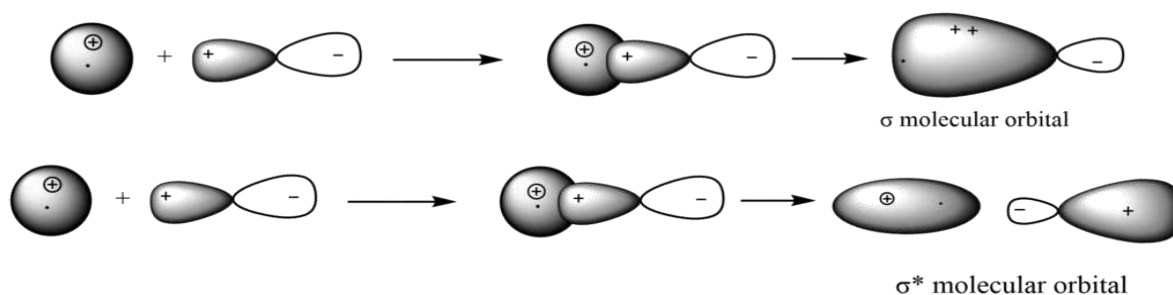

c. P-P overlapping

Three types of p- orbitals overlapping viz P_x, P_y, and P_z. are there.

i. P_x – P_x overlap

When two P_x atomic orbitals of the same energy overlap, they form a bonding molecular orbital through addition overlap and an antibonding molecular orbital through subtraction overlap.

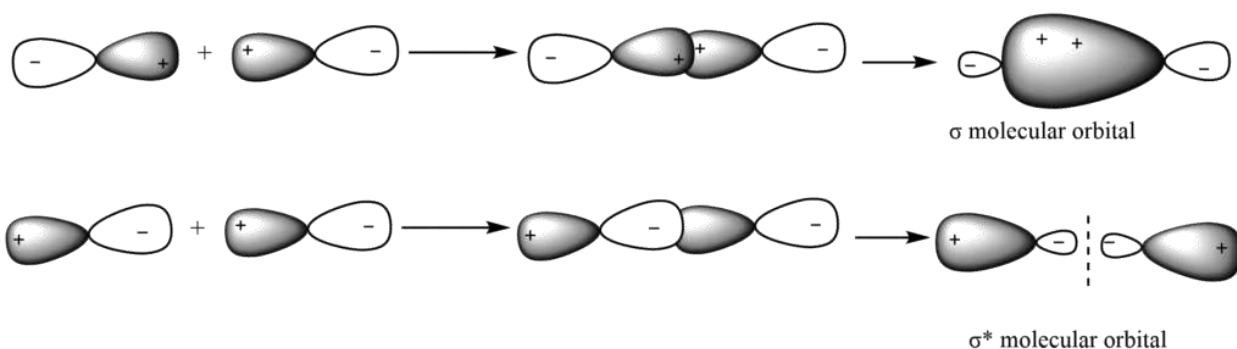

ii. P_y – P_y overlap

When two P_y atomic orbitals of similar energy overlap, they create a π bonding molecular orbital additive effect and π^* antibonding molecular orbital by subtraction effect simultaneously.

ii. P_z – P_z overlap

When two P_z atomic orbitals of similar energy overlap, they create a π bonding molecular orbital additive effect and π^* antibonding molecular orbital by subtraction effect simultaneously.

6.2.2 Non-bonding overlapping

When atomic orbitals combine, they form both bonding and antibonding molecular orbitals. Adding two atomic orbitals creates a stable, low-energy bonding MO, while subtracting them creates an unstable, high-energy antibonding MO. However, when atomic orbitals experience both addition and subtraction overlap simultaneously, a third type of overlapping occurs. This neither stabilizes nor destabilizes the resulting molecular orbital.

6.2.3 Condition of LCAO

For atomic orbitals to merge and form molecular orbitals (MOs), certain conditions must be met:

1. **Equivalent Energy of AOs:** The atomic orbitals involved in MO formation should possess the same or similar energy levels. For example, in homonuclear diatomic molecules like H₂, N₂, or O₂, overlap between 1s-1s and 2s-2s orbitals is feasible, but overlap between 1s-2s and 1s-2p orbitals is not. However, in heteronuclear diatomic molecules like HCl or HF, such overlapping is expected.
2. **Significant Overlap of AOs:** There needs to be a substantial degree of overlap between the atomic orbitals. The greater the extent of overlapping if electron density is higher between the nuclei. This principle is often referred to as the "maximum overlapping principle."
3. **Similar Symmetry of AOs:** Merely having similar energy levels is not sufficient for atomic orbitals to combine into MOs. They must also possess the same symmetry (or orientation) with respect to the molecular axis. In other words, their spatial arrangement around the molecular axis should be compatible for MO formation.

6.3 Characteristics of MOT

The key characteristics of Molecular Orbital Theory (MOT) are:

1. **Complete Mixing of AOs:** All atomic orbitals of combining atoms merge to form new molecular orbitals (MOs), obscuring the individual identities of the original AOs.
2. **Number of MOs Equals Combining AOs:** The total MOs formed equals the total combining atomic orbitals, resulting from their linear combination.
3. **Bonding and Antibonding MOs from Overlap:** Bonding MOs arise from addition overlap, while antibonding MOs result from subtraction overlap.
4. **Variation in Energy, Size, and Shape:** MOs can differ in energy, extent, and shape, influenced by the combining AOs.
5. **Shape Determined by AOs:** The shape of MOs primarily depends on the shapes and orientations of the combining AOs.
6. **Representation of Electrons through Wave Functions:** Electrons in MOs are described by their wave functions, indicating the probability of finding electrons within them.
7. **Adherence to Quantum Mechanical Principles:** MOT follows principles like the Aufbau principle, Pauli's exclusion principle, and Hund's rule, governing the filling of electrons in MOs and ensuring stability according to quantum mechanics.

6.4 Bond Order

The number of electrons in bonding and antibonding molecular orbitals can be shown by filled molecular orbital diagram. The bond order that results from electrons filling up molecular orbitals is used to quantify the net contribution of electrons to a molecule's bond strength.

$$\begin{aligned}\text{Bond order} &= \text{Total electrons in bonding MO} - \text{Total electrons in antibonding} / 2 \\ &= (N_b - N_a) / 2\end{aligned}$$

6.4.1 Characteristics of Bond Order

Bond order characteristics summarized:

1. **Key to Stability and Energy:** Stability, bond energy, and bond dissociation energy are closely tied to bond order.
2. **Inversely Proportional to Bond Length:** Bond length decreases as bond order increases, and vice versa.
3. **Indicator of Stability:** A bond order of zero signifies instability or nonexistence of the molecular structure.

6.4.2 Magnetic Properties

The number of unpaired electrons in molecular orbitals determines the magnetic characteristics of the molecules. If one or more unpaired electrons are there then molecules are Paramagnetic in nature whereas if no unpaired electrons are there molecules are diamagnetic in nature. Magnetic moment (μ) can be calculated as:

$$\mu = \sqrt{n(n+2)} \text{ B.M.}$$

where n is unpaired electrons number.

6.4.3 Molecular orbital diagrams and stability

I. H_2 molecule

Hydrogen's Electronic configuration = 1S^1

Number of electrons in H_2 molecule = 2

Electronic configuration for Molecular orbital of H_2 molecule = $(\sigma 1\text{S})^2, (\sigma^* 1\text{S})^0$

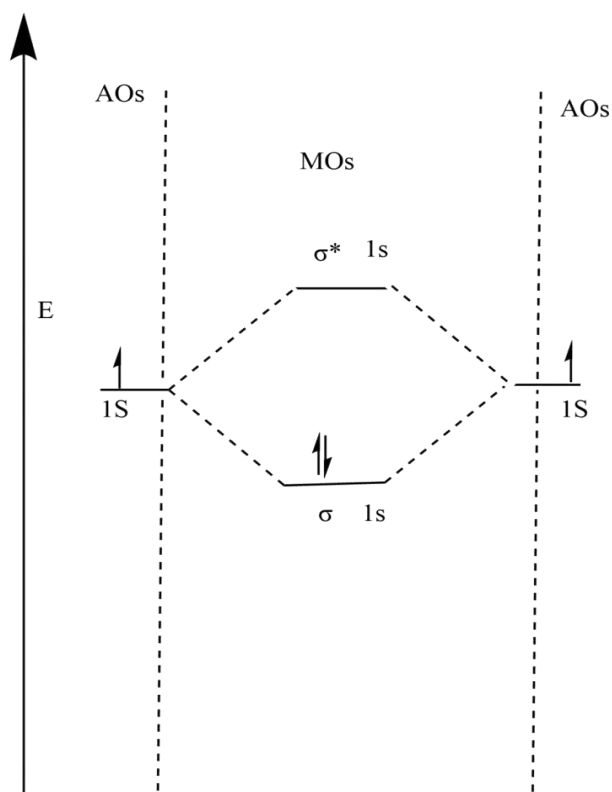

Figure 6.1: Molecular orbital diagram for H₂ molecule

Firstly two electrons are found in σ 1s molecular orbital

$$\text{bond order} = (\text{Nb} - \text{Na}) / 2$$

$$= 2 - 0 / 2$$

$$= 1$$

It means single bond present between two H-atoms in H₂.

Due to absence of unpaired electron H₂ is Diamagnetic

II. Li₂ molecule

Lithium's Electronic configuration = $1S^2, 2S^1$

Number of electrons in Li₂ molecule = $3 \times 2 = 6$

Electronic configuration for Molecular orbital of Li₂ molecule = $(\sigma 1S)^2, (\sigma^* 1S)^2, (\sigma 2S)^2$

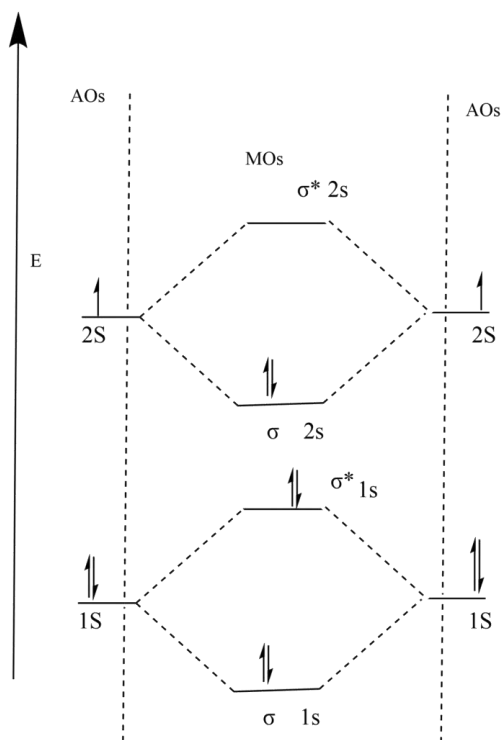

Figure 6.2: Molecular orbital diagram for Li_2 molecule

$$\begin{aligned} \text{bond order} &= (\text{Nb} - \text{Na}) / 2 \\ &= 4 - 2 / 2 \\ &= 1 \end{aligned}$$

Li exists as Li_2 molecule in vapour state and it is diamagnetic in nature.

6.5 Molecular Orbital Electronic Configurations of Homonuclear Diatomic Molecules

6.5.1 Introduction

Molecules formed from two atoms per molecule are known as diatomic molecules. The molecules thus formed are attracted to each other with the help of covalent chemical bonds. Remember, the atoms combined can be with the help of a single, double and triple bonds. Depending on the types of atoms used during the formation of molecules, the diatomic molecules are divided into two main types – **homonuclear and heteronuclear diatomic molecules**. Though both the molecules are formed with the help of two atoms yet, they are quite different from each other. Read out the article to know more about **homonuclear diatomic molecules** and the molecular orbital treatment.

6.5.2 Homonuclear Diatomic Molecules

Also known as mononuclear molecules, these molecules are formed from the combination of two substances with the same chemical properties. These two elements are known to bond each other with the help of covalent chemical bonds. For this reason, **homo diatomic molecules** have two same atoms present in them. Some of the atoms known to have homonuclear diatomic bonding are oxygen, hydrogen, halogen, and nitrogen.

Remember, noble or inert gasses don't form diatomic molecules. The homonuclear diatomic molecules are known as nonpolar molecules because of zero electronegativity difference between them. The two atoms that form chemical bonds are the same, which means both have the similar electronegativity. The electron pairs are evenly distributed, meaning there's no shift. Hence, the homonuclear molecules are nonpolar.

However, the bond present between them can be single, double or triple, as per the demand of the atoms and the valence electrons. Let's check out the examples of homonuclear diatomic molecules with single, double, and triple bonds present in them.

1. Nitrogen molecule (N_2), having triple bond present between two nitrogen atoms
2. Oxygen molecule (O_2), having a double bond present between two oxygen atoms
3. Hydrogen molecule (H_2), having a single bond present between two hydrogen atoms.

6.5.3 Heteronuclear Diatomic Molecules

Unlike homonuclear diatomic molecules, heteronuclear diatomic molecules are made of two different types of atoms. They are known to club different atoms with the help of covalent chemical bonds. Meaning the chemical properties of the two atoms used in the molecule formation are different. Some of the examples of heteronuclear diatomic molecules are Carbon monoxide, Nitrogen oxide, Hydrogen fluoride, and much more.

Remember, the bond present in the heteronuclear diatomic molecules is always polar. The reason is the difference in electronegativity prevailing between the two attached atoms. When two different atoms with different chemical bonds are attached, one of the atoms present in it has a high electronegativity value as compared to the other. This results in the shifting of the

electronic pair towards the more electronegative element. Thus, giving rise to the polar nature of the molecule.

Similar to **homonuclear diatomic molecules**, heteronuclear diatomic molecules can have single, triple, and double bonds present between the two atoms attached. Here are examples of heteronuclear diatomic molecules with their bonding criteria.

1. Carbon monoxide (CO) has a triple bond present between two different atoms – carbon and oxygen. Oxygen being more electronegative will attract the electron pair towards itself, indicating the polar nature of the molecule.
2. Nitrogen oxide (NO) has a double bond present between two different atoms – nitrogen and oxygen. Oxygen being more electronegative will attract the electron pair towards itself.
3. Hydrogen fluoride (HF) has a single bond present between two different atoms – hydrogen and fluorine. Fluorine will attract the electron pair towards itself as it is more electronegative, establishing a polar bond linking the atoms.

What are the similarities between homonuclear and heteronuclear diatomic molecules?

Though both molecules have different bonding criteria yet, there are certain similarities. Check out a few similar qualities that both homonuclear and heteronuclear diatomic molecules possess.

1. When the atoms are bonded with each other, they both utilise two atoms per bonding.
2. The geometry of both heteronuclear and homonuclear diatomic molecules is linear.
3. Covalent chemical bond is present between both homonuclear and heteronuclear diatomic molecules.

6.5.4 Key differences between Homonuclear and Heteronuclear Diatomic Molecules

Now let's discuss the differences between the two types of diatomic molecules. These are –

1. During homonuclear diatomic molecule bonding, the two atoms have chemical properties. On the other hand, during heteronuclear diatomic molecules, the two atoms have different chemical properties. However, in both cases, the chemical bond is covalent.

2. Homonuclear diatomic molecules have stable isotopes that don't undergo any radioactive decay. Alternatively, heteronuclear diatomic molecules come with different chemical elements and don't form stable isotopes.
3. Homonuclear diatomic molecules possess nonpolar chemical bonding. On the other hand, heteronuclear diatomic molecules possess polar bonds.
4. Homonuclear diatomic molecules have identical atoms. Heteronuclear diatomic molecules have different atoms bonded.

6.5.5 MO Treatment of Homonuclear Diatomic Molecules

A molecular orbital is a way to find out the filling of electrons in a particular bond formation. Let's explain the MO treatment of homonuclear diatomic molecules by taking the example of hydrogen molecule (H_2).

Hydrogen Molecule (H_2) – When two H-atoms are combined, it results in the formation of (H_2) molecule. As we know, each H-atom has one electron in its outermost shell, that is, one s-orbital. Thus, two atoms of hydrogen will have two electrons present in their shell. The electrons present are fixed in the molecular orbital that has lower energy in it. While pairing the electrons, each of the electron bonds must have opposite spins according to the Pauli exclusion principle. With the help of molecular theory, the bond length, bond dissociation energy, and bond order can be easily calculated. Due to the unavailability of unpaired electrons, it is diamagnetic in nature. Similar to the hydrogen molecule, we can calculate the same aspects in other **homonuclear diatomic molecules** with the help of molecular orbital theory.

6.6 Comparing Valence Bond Theory (VBT) with Molecular Orbital Theory (MOT) Similarity

Similarities between VBT and MOT:

1. **Limit on Electron Count:** Both theories adhere to the principle that each orbital can accommodate a maximum of two electrons, whether in atomic or molecular systems.
2. **Consideration of Electron Sharing:** Both theories recognize the sharing of electrons between nuclei as a fundamental aspect of chemical bonding.

3. **Requirement for Comparable Energy and Symmetry:** In both VBT and MOT, the energy levels of overlapping orbitals must be similar, and their symmetry must match for effective bonding to occur.

Dissimilarity

VBT	MOT
Bonds are localized to atoms not the molecule.	Bonds are localized to atoms as well as molecules.
Resonance play key role.	No role of resonance.
Paramagnetic character of oxygen cannot be explained by this theory.	Paramagnetic character of oxygen. Can be satisfactorily explained by this theory.
Calculations are very simple.	Calculations are quiet difficult.

Summary

The MO approaches for understanding chemical bonding by considering the combination of atomic orbitals to form molecular orbitals (MOs). LCAO method is used to construct MOs.

In the MO approach, bonding MOs are formed when atomic orbitals constructively interfere, leading to electron density between the nuclei and stabilizing the molecule. The characteristics of bonding and antibonding MOs vary depending on the combination of atomic orbitals involved, such as s-s, s-p, and p-p combinations. Additionally, nonbonding combinations of orbitals may occur, contributing to the electronic structure of the molecule.

Comparing the MO approach with the Valence Bond (VB) approach, the MO approach provides a more comprehensive description of chemical bonding, incorporating concepts such as electron delocalization and s-p mixing that are not accounted for in the VB approach.

Keywords

Molecular Orbital: arrangement of atomic orbitals.

Bonding and anti-bonding: MOs: formed by constructive and destructive interference between atomic orbitals

Diatomic molecules: Molecules composed of two identical and non-identical atoms.

MCQs

1. Which method is used to construct molecular orbitals in the MO approach?
 - a) LCAO
 - b) VBT
 - c) MOT
 - d) CFT

Answer: A

2. What is the primary characteristic of bonding molecular orbitals?
 - a) They have higher energy than atomic orbitals.
 - b) They result from destructive interference between atomic orbitals.
 - c) They lead to destabilization of the molecule.
 - d) They have electron density between nuclei.

Answer: D

3. In the MO treatment of homonuclear diatomic molecules, what is the concept of s-p mixing?
 - a) Mixing of s and p orbitals to form MOs with intermediate energies.
 - b) Mixing of s and d orbitals to form hybrid orbitals.
 - c) Mixing of p orbitals of different symmetry to form antibonding orbitals.
 - d) Mixing of s and f orbitals.

Answer: A

4. Which type of arrangement of atomic orbitals leads to the formation of nonbonding molecular orbitals?
 - a) s-s
 - b) s-p
 - c) p-p
 - d) d-d

Answer: B

Self-assessment

1. Describe the characteristics of bonding and antibonding molecular orbitals and their significance in chemical bonding.
2. How does s-p mixing affect the molecular orbitals in homonuclear diatomic molecules?
3. Provide examples of heteronuclear diatomic molecules and discuss their molecular orbital treatment.
4. Compare the VBT & MOT approaches to chemical bonding, highlighting their differences and similarities.

UNIT – 7

Electronic Effects

Objectives

- Understand the physical effects in organic molecules.
- Understand electronic displacements in organic molecules.
- Explore the concepts of Hyperconjugation, Inductive effect, Electromeric effect and Resonance.

7.1 Electronic Displacement In Covalent Bonds

The electronic effects that function in covalent bonds are described as follows:

- Inductive effect
- Resonance and mesomeric effect
- Hyperconjugation

7.1.1 Inductive effect

In the ethane the C–C bond nonpolar since it formed between two same atoms. However, the existence of the electronegative chlorine atom in ethyl chloride causes the C–C bond to become polarized. This polarization is really the addition of three effects. Firstly, the strong electronegativity of chlorine atom diminished the electron density at C₁. Secondly, the electron scarcity of C₁ is moderately adjusted by drawing the C–C electrons nearer to itself, subsequent in polarization of this bond and a slight positive charge on the C₂ atom. Thirdly, the C–C bond's polarization results in a (minimal) polarization of the three methyl C–H bonds. In comparison to Cl's effect on the C₁ atom, C₁ has a smaller effect on C₂.

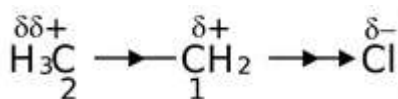

Apart from the inductive effect acting on the σ -bonds within a chemical, a similar phenomenon known as the field effect can also function in solution via the solvent molecules surrounding the molecule or in the surrounding space. There is a difference between the two effects: the field effect is dependent on the geometry of the substance, but the inductive effect solely is based on the type of links.

In ethyl chloride, the Cl atom has electron withdrawing effect due to $-I$ effect. Other kinds of groups that release electrons and have the $+I$ effect. Therefore, with respect to hydrogen, all substituents and functional groups can be categorized as electron-donating ($+I$) or electron-withdrawing ($-I$) groups. The most common groups have decreasing inductive effects in the following sequence.

$+I$ groups : O^- , CO_2^- , CR_3 , CHR_2 , CH_2R , CH_3 , D

$-I$ groups : NR_3^+ , SR_2^+ , NH_3^+ , NO_2 , SO_2R , CN , CO_2H , F , Cl , Br , I , OAr , $COOR$, OR , COR , SH , OH , $C \equiv CR$, Ar , $CH = CR_2$

To analyse the comparative inductive effects, in the molecule $CR_3 - H$ the hydrogen atom is selected as standard. When the H atom is changed by X (an atom or group of atoms) if the electron density on CR_3 is reduced, then X having $-I$ effect (electron withdrawing). Another side if the CR_3 part becomes more electron dense in this situation the X shows $+I$ effect (electron releasing).

When alkyl group gets attached to an unsaturated carbon or other atom it exhibits the $+I$ effect. As comparison to hydrogen the nature of Deuterium atom is also electron donating. The atoms with sp bonding usually have a more electron withdrawing capacity than atoms having sp^2 bonding and the sp^2 bonding atom contain more electron-withdrawing power than sp^3 bonding. Due to this fact the aryl, vinylic and alkynyl groups exhibit $-I$ effect.

The comparison of stabilities of carbocations are as

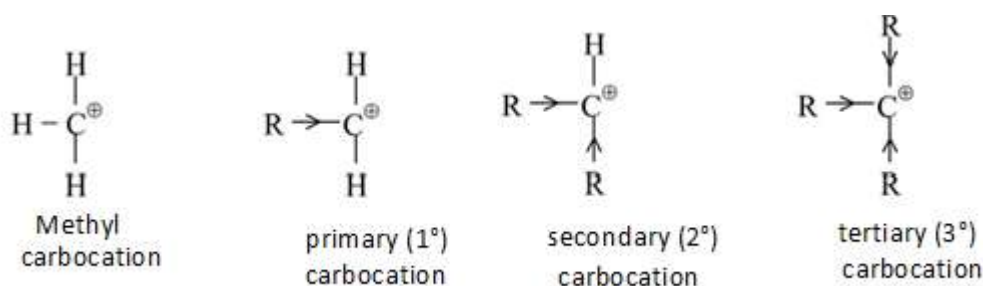

A primary (1°) carbocation is the one in which carbon having the $+ve$ charge is attached to one carbon.

A secondary (2°) carbocation is the one in which the carbon having the $+ve$ charge is attached to two carbons.

A tertiary (3°) carbocation is the one in which the carbon having the +ve charge is attached to three carbons.

7.1.2 Resonance & Mesomeric Effect

There are numerous organic compounds for which a single Lewis structure is insufficient and structure of these molecules given by greater than one Lewis chemical structure known as canonical structures. Resonance is the phenomenon shown by these substances. For instance, the following is the resonance structure of 1,3-butadiene and vinyl chloride has the following canonical forms

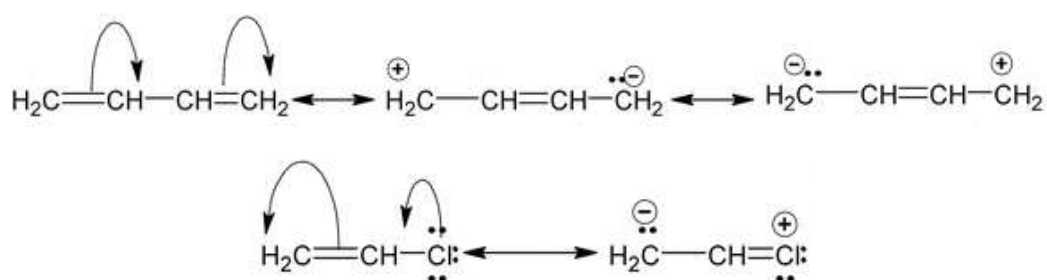

One of the most important things to remember while sketching these canonical forms is that, although we can alter the relative locations of π -bonded electron pairs or the allocation of charge among other atoms, the relative positions of any one atom must not change. Every molecule in the material has the same structure. Its weighted average of all the canonical forms ensures that the structure remains constant over time. We may now talk about what has to happen for a molecule to exhibit resonance. Two conditions that must be fulfilled are

- (a) In the molecule, conjugation is required. Conjugation is the compound's alternate existence of single and double bonds, such as

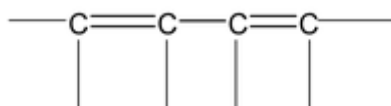

- (b) The conjugation-containing portion of the molecules must be planer or almost planer. Not only is the first requirement of conjugation limited to the previously stated system; conjugation also encompasses several additional systems. These are

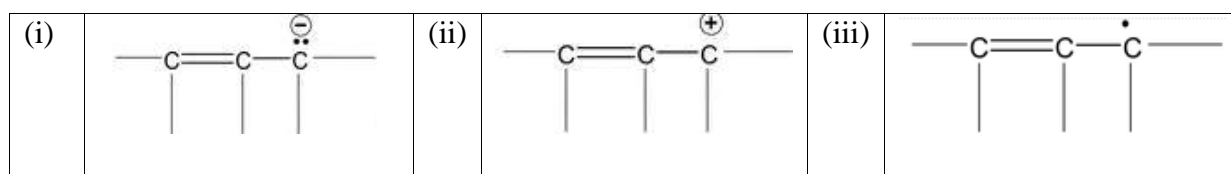

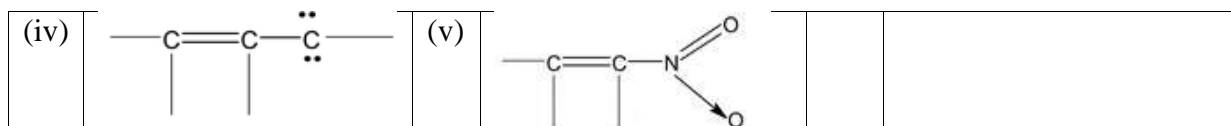

There are two kinds of resonance (mesomeric) effects.

- (i) Resonance occurs when an atom or group of atoms gives out an electron; this is referred to as +R or +M effect. For example,

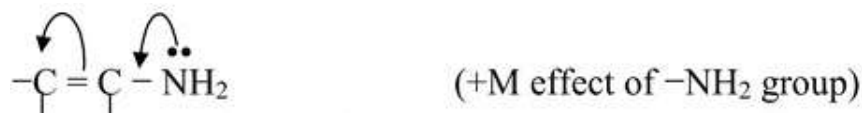

Some more groups shows +M effect are $-\text{NHR}$, $-\text{NR}_2$, $-\text{OH}$, $-\text{OR}$, $-\text{NHCOR}$, $-\text{Cl}$, $-\text{Br}$, $-\text{I}$ etc.

- (ii) The term "-R" or "-M effect" refers to the process of an atom or collection of atoms withdrawing electrons through resonance. *For example,*

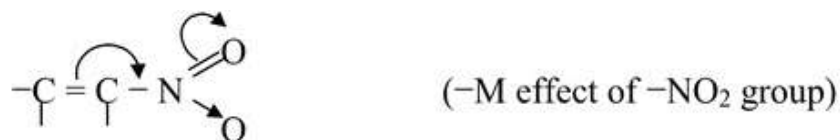

Other groups showing -M effect are $-\text{CN}$, $-\text{CHO}$, $-\text{COR}$, $-\text{CO}_2\text{H}$, $-\text{CO}_2\text{R}$, $-\text{CONH}_2$, $-\text{SO}_3\text{H}$, $-\text{COCl}$ etc.

Now, let us consider resonance in nitrobenzene and its various canonical structures are

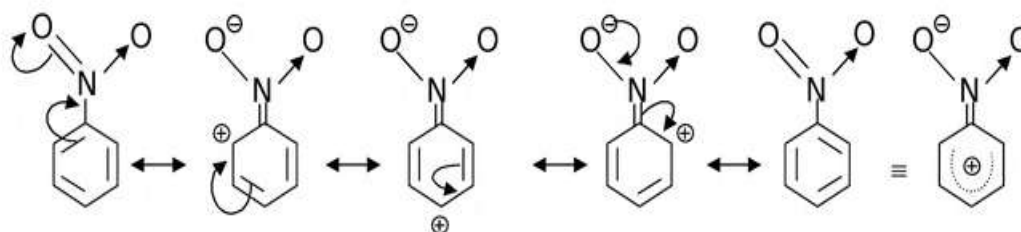

The $-\text{NO}_2$ group in nitrobenzene has -M effect. In general, if any atom (of the group) attached to the carbon of benzene ring bears at least one lone pair, then the group shows +M effect while if the atom (of the group) linked to the benzene carbon bears either a partial or full positive charge, then the group exhibits -M effect.

Example:1 Draw resonance structures for

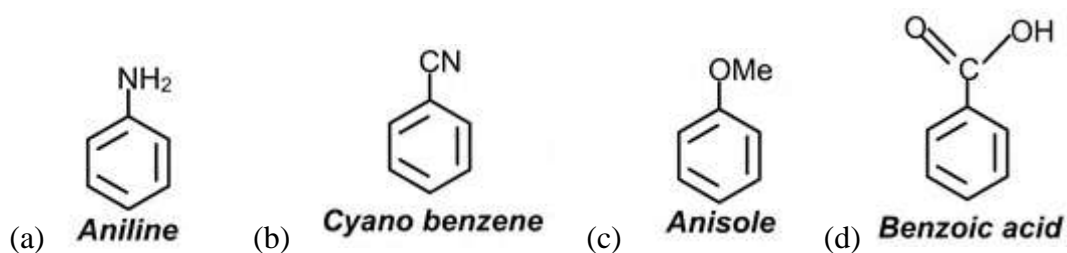

Solution

(a)

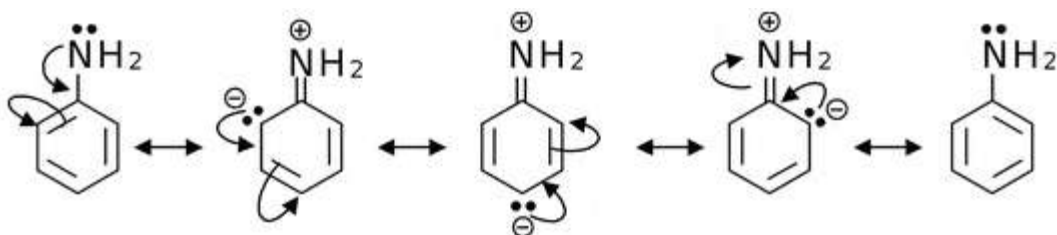

(b)

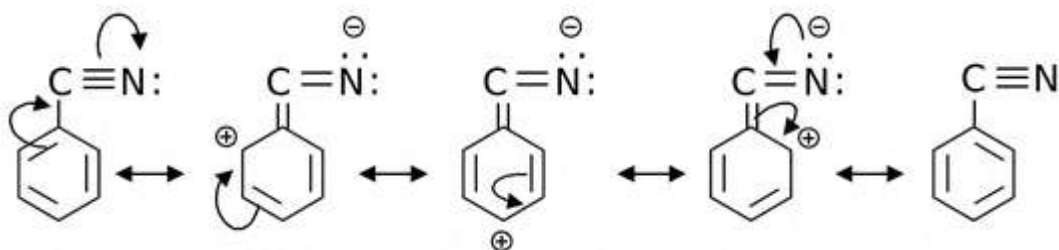

(c)

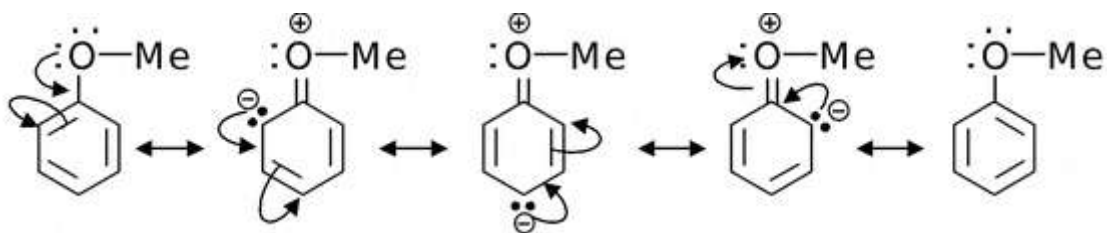

(d)

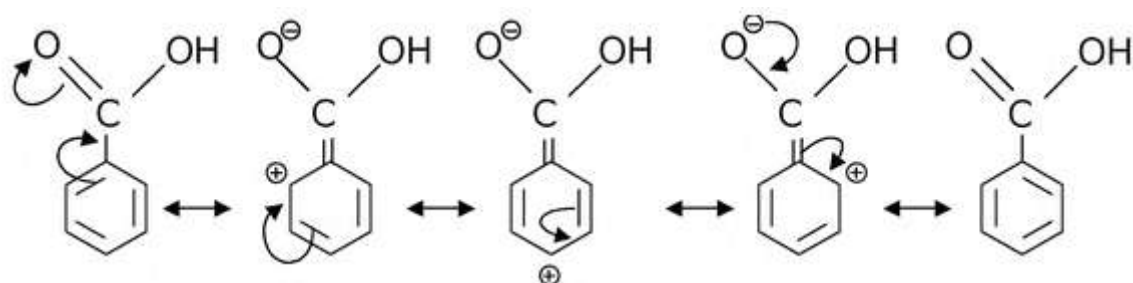

7.1.3 Hyperconjugation

- Sigma electrons or lone pairs of electrons delocalize into adjacent empty or partially full p-or pi-orbitals, a process known as hyperconjugation.

- Hyperconjugation is known also called “sigma-pi-conjugation” or “no bond resonance”

Existence of α -H in relation to unpaired electrons (found in free radicals) or double- or triple-bond carbons carrying a +ve charge found in carbonium ions.

Example

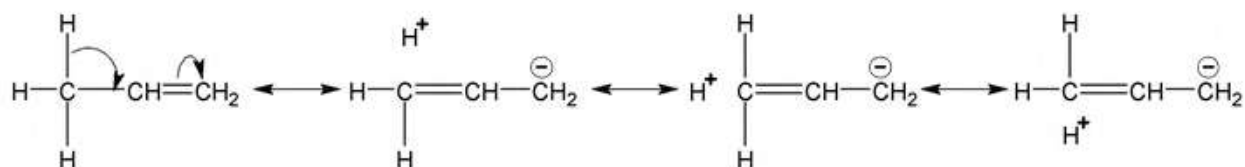

Number of hyper-conjugated structures = No of α -hydrogen. Therefore, in above examples the four structures are hyper-conjugate structures.

The traditional forms are depicted as follows when the CH_3 group is joined to an unsaturated or unshared orbital atom

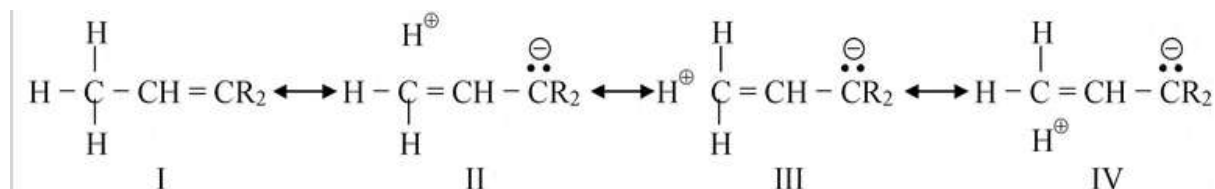

These canonical forms have not connection at within all the hydrogen and carbon atom, but the hydrogen is not apart as H^+ and not acidic in nature and follows the resonance condition, which states that the atoms in a molecule should remain in their relative positions.

The bonded electrons of carbon and hydrogen bond (C-H) are now closer to the carbon than they would be in the absence of any contribution from II, III, or IV, resulting in an influence on the molecule. The hyperconjugation is further reduced for the different alkyl groups such C_2H_5 , $\text{CH}(\text{CH}_3)_2$, and $\text{C}(\text{CH}_3)_3$, as a result of a reduction in the number of C-H bond. Therefore, methyl group is the greatest and t-butyl the weakest electron donor in respect to hyperconjugation effect.

Stability of Intermediates

The laws of physics state that the dispersal of charge increases the stability of a charged system. Any factor, which tries to spread out the positive charge of the deficient carbon of carbocation, must stabilize it.

The current example demonstrates that more number of alkyl groups bonded to the carbocation's positive carbon, the stability of carbocation will be stronger. The reason behind is that the alkyl groups having +I effect and due to its electron donating nature they partially reduced the positive charge of the carbocationic carbon. Hence, the order of stability of carbocations would be

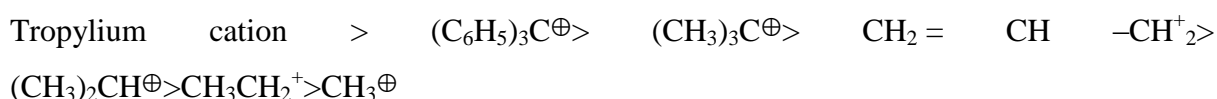

Secondary > Primary > Methyl Carbocation

Explanation: Tropylium cation, $(\text{C}_6\text{H}_5)_3\text{C}^\oplus$, $\text{CH}_2 = \text{CH} - \overset{\oplus}{\text{C}}\text{H}_2$ stabilized by resonance only where as $(\text{CH}_3)_3\text{C}^\oplus$, $(\text{CH}_3)_2\text{CH}^\oplus$ and $\text{CH}_3\text{CH}_2^\oplus$ Carbocation are stabilized by both inductive and hyper conjugation effect.

The presence of electron attracting group (-I group) would decrease the stability of carbocation.

Similarly, the stability of a free radical can be increased by the presence of +I groups and decreased by the presence of -I groups. Thus, the order of stability of free radicals would be
Benzyl > Allyl > 3° free-radical > 2° free-radical > 1° free-radical > methyl free-radical

Explanation: Benzyl and allyl radicals are stabilized by resonance whereas alkyl radicals are stabilized by hyperconjugation.

In carbanions, the existence of electron donating groups (+I groups) would destabilize it while presence of electron withdrawing groups (-I groups) would stabilize it. Thus the order of stability of carbanions would be

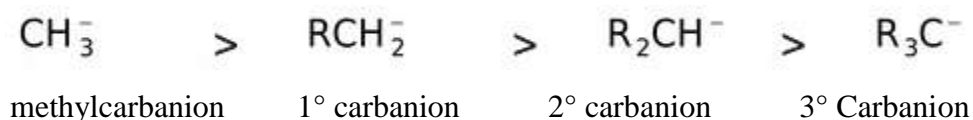

Phenyl > Methyl > Ethyl > n-propyl > isopropyl > isobutyl

Explanation: All carbon atoms of phenyl anions are sp^2 hybridised whereas other anions of the above order are in sp^3 hybridised s

Summary

Organic chemistry encompasses a wide range of physical effects and electronic displacements that play crucial roles in the behavior of organic molecules. The inductive effect involves the polarization of a σ -bond due to differences in electronegativity, resulting in the transmission of electron density along a chain of atoms.

Keywords

Inductive effect: transmission of electron density along a chain of atoms via σ -bonds.

Electromeric effect: The transient displacement of σ -electron pairs in a conjugated system.

Resonance: A phenomenon observed in molecules with delocalized π -electrons, where multiple Lewis structures.

MCQs

1. Which effect involves the polarization of a σ -bond due to differences in electronegativity?
 - a) Electromeric Effect
 - b) Hyperconjugation
 - c) Inductive Effect
 - d) Resonance

Answer: C

2. What is the transient displacement of σ -electron pairs in a conjugated system called?
 - a) Inductive Effect
 - b) Electromeric Effect
 - c) Resonance
 - d) Hyperconjugation

Answer: B

3. Resonance in organic molecules involves the delocalization of which type of electrons?
- a) σ -electrons
 - b) π -electrons
 - c) δ -electrons
 - d) ϕ -electrons

Answer B

4. Hyperconjugation leads to the stabilization of molecules through the overlap of which orbitals?
- a) σ -bonding orbitals
 - b) π -bonding orbitals
 - c) σ -antibonding orbitals
 - d) π -antibonding orbitals

Answer: A

Self-assessment

1. Explain the Inductive Effect and provide an example.
2. Describe the mechanism of Electromeric Effect with an illustration.
3. How does Resonance contribute to the stability of molecules? Provide an example.
4. Discuss the concept of Hyperconjugation and its significance in organic chemistry

UNIT – 8

Reactive Intermediates

Objectives

- Learn about the cleavage of bonds through homolysis and heterolysis reactions.
- Analyze the shape, structure and reactivity of molecules.
- Identify and characterize reactive intermediates

8.1 Homolytic and Heterolytic Fission: Explained With Conditions & Examples

In chemistry, the breaking of chemical bonds is referred to as bond cleavage or bond fission. Depending on the type of process, bond cleavage can be broken down into two main categories: homolytic and heterolytic fission. Only one bond electron from the sigma bond is allocated to each molecule's fragment or entity during homolytic fission. In heterolytic fission distributes two bond electrons are distributed to each fragment. In this Chemistry article learn about the Homolytic and Heterolytic fission here. Also learn about the difference between homolytic and heterolytic fission here, conditions, definitions and examples.

8.1.1 Homolytic Fission

- Homolytic fission consist of the distribution of only one bond electron to each component of the molecule.
- This resulted into the reactive radical species like $\text{Cl}\cdot$, $\text{CH}_3\text{CH}_2\cdot$, $\text{CH}_3\text{CH}_2\cdot$, $\text{CH}_3\text{CH}_2\cdot$.

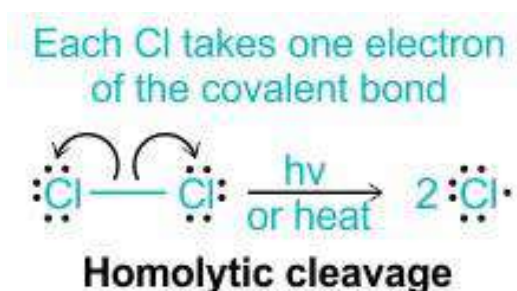

- The energy utilized in the process of homolytic fission is known as bond dissociation energy (BDE).
- It is referred as per mole of enthalpy required to break bond in molecule.

- Stronger bonds require more bond dissociation enthalpy for homolytic fission.

8.1.2 Condition for Homolytic Fission

Homolytic fission requires a high amount of energy to break a bond equally.

The following are the conditions that favour homolytic fission:

- The electronegativity difference between the two entities of the compound should be less.
- Non-polar nature of the bond favours homolytic fission.
- When the molecule is heated to the necessary level to dissipate the bond dissociation energy.
- The compound is exposed to a high-temperature condition.
- The compound is subjected to UV radiation, electric current, or peroxides.

Homolytic Fission Example

Some of the most common examples of homolytic fission are discussed as follows:

- Homolytic fission of chlorine molecule in the presence of UV radiation or heat.

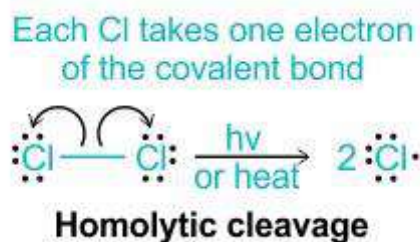

- Formation of an alkyl radical in the presence of chlorine radical.

These arrows show formation of a new bond (H - Cl)

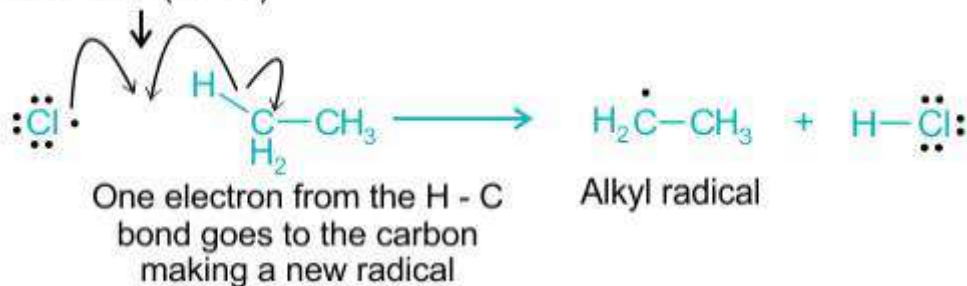

- Formation of alkoxy radical from peroxides in the presence of heat or UV radiation.

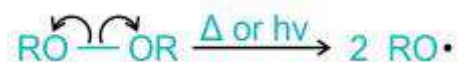

8.1.3 Heterolytic Fission

- When the bond breakup takes place in such a way that the shared electron pair is completely transferred on a single entity.
- One fragment of the compound acquired an extra electron while the other suffers a loss of one electron.
- It is also called as ionic fission.
- The positive entity is known as cation while the negative component is called as anion.

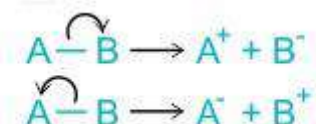

The formation of carbocations and carbanions is also explained in terms of heterolytic fission.

- The requisite energy to break a chemical bond via heterolytic fission is called as heterolytic bond dissociation enthalpy.

8.1.4 Conditions of Heterolytic Fission

The conditions required for heterolytic fission are as follows:

- The electronegativity difference among the two bonded atoms of a molecule should be high.
- As a result, the component with more electronegativity attracts the electron pair.
- This leads to the transfer of bonded electron pair only to one fragment of the bond.
- Simply put, a polar molecule favours heterolytic fission.
- When the compound is subjected to low temperature or a polar solvent.

Heterolytic Fission Examples

The most commonly observed examples of heterolytic fission are as follows:

- In hydrochloric acid, the bond is broken via heterolytic fission.

- The chlorine atom is highly electronegative.
- It attracts the electron pair towards itself.
- Formation of carbocation during the S_N1 reaction of bromoalkane.

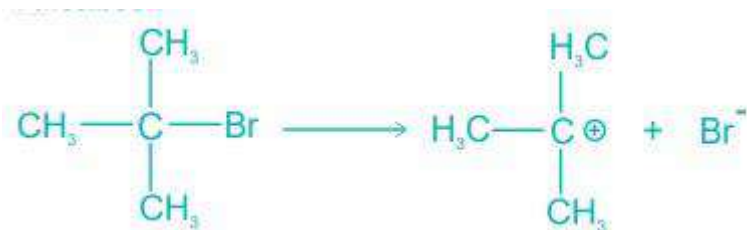

8.2 Nucleophiles and Electrophiles

With the series of discussing about the location and flow of electrons, in this section we will talk about the fundamental principles of chemistry, that like charges repel one another and opposite charges attract one another, and that in reactions, electrons move from “electron rich” to “electron poor” regions.

The species which are electron rich are called nucleophiles while those which are electron deficient are called electrophiles.

1. A ‘Nucleophile’ (“nucleus loving”, or “positive-charge loving”) in a reaction provides or donates a pair of electrons for the formation of a new covalent bond. Stated another way, nucleophiles or nucleus loving species are Lewis bases. When a proton (H^+) accepts a pair of electrons from a species (nucleophile) than that specie is called as Brønsted base, or simply, “base”.

Few examples of Lewis bases from which we are probably familiar are given below.

Example:

Lewis bases



Now we have seen that nucleophiles are rich in electrons and possess pairs of electrons to donate in a reaction.

Let's discuss a well-known ion: **Hydroxide ion (OH⁻)**

- (a) **Hydroxide ion (OH⁻) as a base:** In the reaction shown below, hydroxide ion donates an electron pair to an acidic proton (H⁺), forming a new covalent bond and acting as 'base' here.

Hydroxide ion as a base

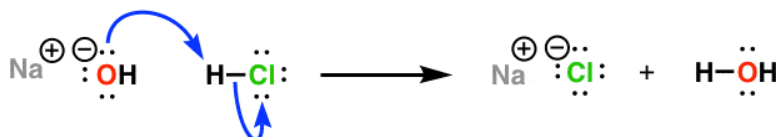

And as we've seen before,

- (b) When an electrophilic atom (such as carbon here) accepts a pair of electrons from hydroxide ion to form a new covalent bond, in that case hydroxide ion act as a **nucleophile**.

Hydroxide ion as a nucleophile

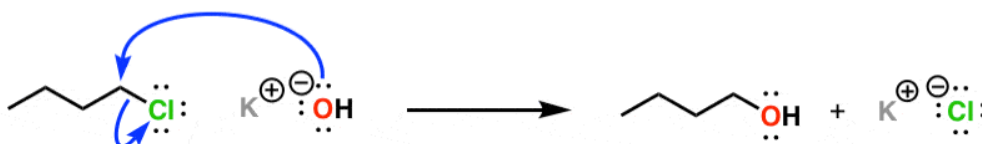

From (a) and (b), it can be predicted that an electron rich specie can act as **nucleophiles and bases** both. Thus, in fact, the “basicity” we've been talking about is a subdivision of “nucleophilicity” – the particular condition where the electrophile is a **proton (H⁺)**.

2. An ‘Electrophile’ (“electron loving”, or “negative-charge loving”) in a reaction accepts a pair of electrons for the formation of a new covalent bond. Stated another way, electrophiles or electron loving species are Lewis acids. When a proton (H⁺) accepts a pair of electrons then it is called as Brønsted acid, or simply, “acid”.

Few examples of Lewis acids from which we are probably familiar are given below.

Example:

Lewis acids

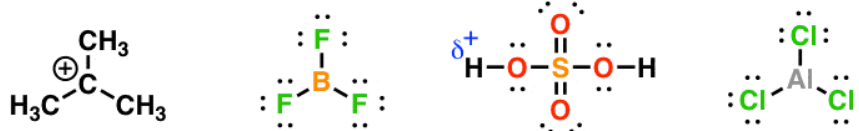

Like nucleophiles, electron deficient species can be both **electrophiles and acids**.

3. “Nucleophilicity” and “Electrophilicity” pertain to the extensiveness of a species to donate or accept an electron pair.

Thus “nucleophilicity” can be defined as “the ease of donation of a pair of electrons by a species. On the other hand the magnitude to accept a lone pair of electrons is called “electrophilicity”.

Thus, “acidity” is a subdivision of “electrophilicity”.

4. The majority of chemical reactions are the reactions that take place between a nucleophile and an electrophile

Overall in a large number of reactions (>95%), nucleophile donates a pair of electrons to an electrophile or nucleophile attacks electrophile.

8.4 Reactive Intermediates

In the following discussion, we shall cover the basics about reactive intermediates in a chemical reaction, their characteristics and different types of reaction intermediates such as carbocation, free radical, carbanions, nitrenes and benzyne with examples in detail.

Related to chemistry, a reactive intermediate is a highly reactive, high-energy, short-lived species that, when produced during a chemical process, swiftly transforms into a chemically stable molecule. They are segregated and kept in some cases. These chemicals can only be separated and preserved in extreme specified conditions, such as low temperatures or matrix isolation.

In most chemical processes, a reactive intermediate exists only in one of the intermediate phases which is short lived and of high-energy. A well-defined mechanism has been developed for successive stages. Reactive intermediates are said to be stable as they are formed by an elementary reaction and destroyed in succeeding step.

Features of Reactive Intermediates

Reactive intermediates share several common characteristics:

- To stabilize a reaction, conjugation or resonance is used.
- they have a low concentration in relation to the reaction substrate
- products are difficult to distinguish from a transition state
- They are frequently formed during the disintegration of a chemical compound

Identification of Reactive Intermediates

It is difficult to make a difference between a transition stage. It's a state that has a reaction coordinate and correlates to potential energy at a higher level. It's a type of chemical process where a particular configuration exists along a reaction coordinate.

Chemical trapping can be used to demonstrate its presence. The chemical trap is just a chemical substance that detects a molecule in specific situations, as shown below:

- When a molecule is present in a mixture, the detection of that molecule is hampered by the presence of components.
- When the molecule's concentration is below the detection limit.
- When a molecule is extremely reactive or cannot be determined by spectroscopic methods.

Reaction intermediate examples

8.4.1 Free radicals

A reactive species with an odd or unpaired electron atom is known as a free radical. These are represented by adding a dot (•) against the symbol of that species (atom or molecule) and came in existence due to the homolytic fission of a covalent bond. Due to the existence of an odd electron, they are paramagnetic in nature and are usually generated in the presence of either UV/visible light or peroxides.

Free radicals are categorized into three groups: Primary, Secondary and Tertiary and their stability lies in the order: **Tertiary** > **Secondary** > **Primary** > **•CH₃**. Its stability is dependent upon the resonance and attachment of electron-donating groups.

8.4.2 Carbocation

When a bond in an organic molecule having more electronegative atom breaks down by heterolytic fission then bonded electron pair moves towards electronegative atom and carbon atom become deficient by one electron with a positive charge. The formation of positive charge carbon moiety is called as Carbocations or carbonium ions.

The charged carbon atom in a carbocation has a “sextet,” which means it only contains six electrons in its outer valence shell, rather than the eight required for optimal stability (octet rule). As a result, carbocations are frequently reactive, attempting to reclaim an octet of valence electrons.

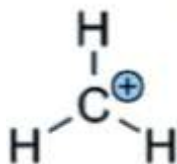

8.4.3 Carbanions

When a bond in an organic molecule having less electronegative atom breaks down by heterolytic fission then less electronegative atom extracted out without electron pair and carbon atom become negative charged. The formation of negative charge carbon moiety is called as Carbanions. Carbanions have a diamagnetic property. These are extremely reactive because the negatively-charged carbon in them is electron-rich and possess tendency to transfer its lone pair of electrons to another group for sharing. Carbanions, as a result, act like nucleophiles and are easily attacked by electrophiles. A carbanion is divided into three categories: primary, secondary, and tertiary.

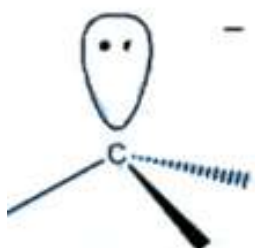

8.4.4 Carbenes

CH₂ is a highly reactive, neutral species. Carbenes are divalent neutral carbon intermediates. It is a form of carbon that has two unpaired electrons but no charge. In carbenes, a total of six valence electrons are present, where two are as lone pairs and four of which are shared (electron-deficient). As a result, Carbenes are neutral, transitory chemical intermediates with a carbon atom that are sp² and sp-hybridized. It is short-lived and diagonal in geometry. The general formula is written as: R-(C:)-R' or R=C: (R is the alternate of hydrogen atoms).

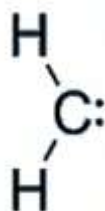

8.4.5 Nitrenes

Organic substances with the general formula R-:N: are known as nitrenes. These are nitrogen intermediates that are similar to carbenes and have a neutral univalent nitrogen (with one covalent bond and two lone electron pairs). These are “electron-deficient species in which nitrogen has a sextet of electrons,” according to the definition (six electrons in the outermost shell).

Because they are deficient by two electrons for the completion of octet, they are extremely reactive and strong electrophiles. :N:-H is the parent species known as nitrene. As it has a higher tendency to polymerize to (NH)_n, hence it is difficult to form. As a result, substituted nitrenes have got a lot of interest.

Nitrenes, like carbenes, can exist in singlet and triplet forms, by replacing a covalent links by a nitrogen lone pair. The ground state is the triplet state. Nitrenes have many applications in organic synthesis like involvement of acyl nitrene in Hofmann, Curtius, and Lossen rearrangements.



8.4.6 Benzyne (1, 2-Dehydrobenzene or Aryne)

Benzyne is a highly reactive and neutral chemical reactive intermediate with a relatively unaltered aromatic property. Benzyne is produced by the nucleophilic substitution of

aromatic compounds as an intermediate. Benzene ring possess a Carbon-Carbon triple bond in it and is resulted by the sideways overlapping of sp² hybridized orbitals of two nearby carbon atoms, resulting in the development of a new weaker C-C bond.

Summary

The cleavage of bonds in organic molecules can occur through homolysis, where a bond breaks symmetrically, leading to the formation of two radicals, or heterolysis, where a bond breaks asymmetrically, resulting in the formation of ions.

The structure, shape, and reactivity of organic molecules are determined by the presence of nucleophiles. Understanding these concepts is crucial in predicting and controlling the outcome of organic reactions. Reactive intermediates are species that are formed transiently during organic reactions. Carbocations are electron-deficient carbon atoms with a positive charge, carbanions are electron-rich carbon atoms with a negative charge, free radicals are species with unpaired electrons, and carbenes are species with a neutral carbon atom bearing two non-bonding valence electrons.

Overall, a thorough understanding of bond cleavage, and reactive intermediates is essential for mastering the principles of organic chemistry and predicting the outcome of organic reactions.

Keywords

Homolysis: The breaking of a bond in a molecule by equally dividing the shared pair of electrons

Carbocation: Reactive intermediates containing a positively charged carbon atom.

Carboanion: Reactive intermediates containing a negatively charged carbon atom

Free Radicals: Reactive intermediates containing an unpaired electron.

MCQs

1. What type of bond cleavage consequence in the formation of two radicals?
 - a) Homolysis
 - b) Heterolysis
 - c) Polymerization
 - d) Condensation

Answer: A

2. Which species are attracted to electron-deficient sites in organic molecules?
- a) Nucleophiles
 - b) Electrophiles
 - c) Radicals
 - d) Carbocations

Answer: A

3. Carbocations are reactive intermediates containing a positively charged _____ atom.
- a) Carbon
 - b) Hydrogen
 - c) Oxygen
 - d) Nitrogen

Answer: A

4. Which type of reactive intermediate contains an unpaired electron?
- a) Carbocations
 - b) Carbanions
 - c) Free radicals
 - d) Carbenes

Answer: C

5. In heterolysis, how are the electrons in a bond divided?
- a) Equally
 - b) Unequally
 - c) Not divided
 - d) Not applicable

Answer B

Self-assessment

- 1. Differentiate between Homolysis and Heterolysis reactions with examples.
- 2. Define Nucleophiles and provide two examples.

3. What are Electrophiles, and how do they react with nucleophiles? Give an example reaction.
4. Describe the characteristics of Carbocations and their role in organic reactions.

UNIT – 9

Aromaticity

Objectives

- Understand the concept of aromaticity in organic chemistry.
- Explore the characteristics and properties of aromatic compounds.
- Learn about benzenoids and their significance in aromatic chemistry.
- Familiarize with Hückel's rule and its application in determining aromaticity.
- Identify aromatic compounds based on their structural features and electronic properties.

9.1 Aromaticity

The compounds that have properties of Benzene ring and compound that contain benzene rings and its condense system which is confined in consequence with Properties of benzene ring is called aromaticity.

9.2 Theory of Aromaticity

1. **Aromatic sextet theory:** This theory is given by Robinson in 1925. According to this theory six electrons are necessary to link the six carbon atoms in benzene ring. Each electron is contributed by six carbon atom to form close group which contain aromatic properties. This close group is possible in Heterocyclic compounds and not possible in Aliphatic and alicyclic compounds.

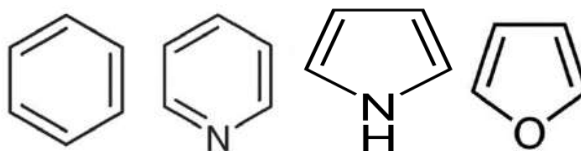

Benzene

Pyridine

Pyrrole

Furan

2. **Valence bond Theory:** According to this theory benzene is a flat hexagonal structure with six hydrogen atoms which are present in same plane The structure confirmation of benzene is ring is done by X-ray analysis. In benzene C-C-H valence angle is 120° . Bond length of C-C is 1.397 \AA which is lies between single bond (1.54 \AA) and double bond (1.33 \AA) thus all the bonds in benzene have double

bond character. There are five possible canonical structures if bonding pair are form by the correlate the spin of six electron in pairs.

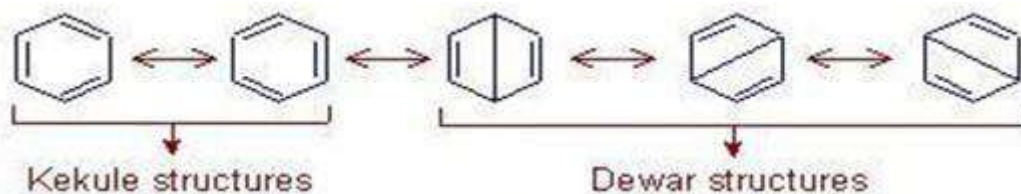

Firstly Kekule structure is known as cyclohex-1,3,5-triene. This compound show that it is not a regular hexagonal structure contains three ethylenic bond and three single bonds. Another condition if resonance is possible than all the structure are same so Kekule structure is not cyclohexatriene. Therefore double bonds in Kekule structure are not ethylenic double bonds. When calculation for five possible structure done show the Kekule structure contribution is 80% and Dewar show 20% contribution in resonance hybrid. Resonance make benzene more stable.

3. **Molecular orbital theory:** Carbon atom in Regular flat hexagonal structure of benzene ring present in trigonal hexagonal hybridization. So there is six sigma C-H bond and six sigma C-C bond are present and six π electrons are present in parallel and perpendicular to the plane of ring. All the six electron are embracing with six carbon atom to form M.O. Three antibonding and three bonding orbitals are present which have nodes in plane of the rings. Furthermore the six 2p_z electrons are occupy the lowest energy level at ground state and when benzene is in excited state one one or more π electrons are placed in excited state.

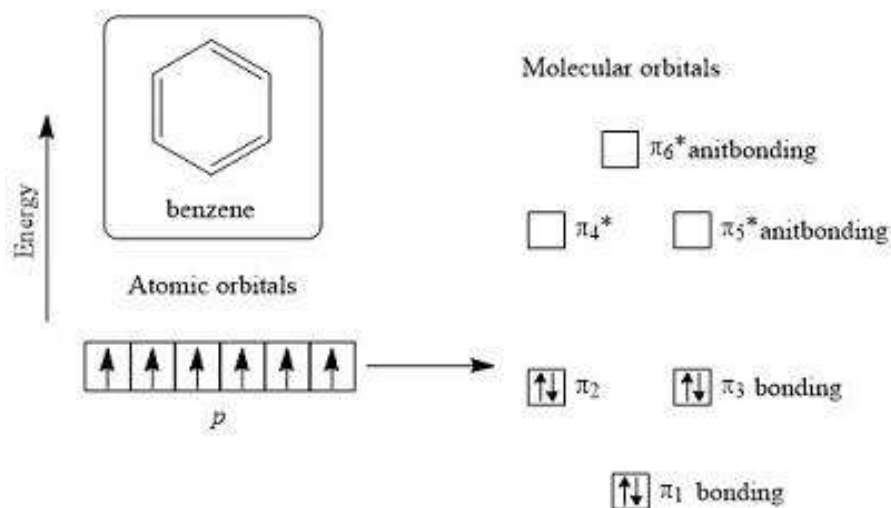

9.3 Aromaticity in Benzenoid and Non benzenoid compounds

1. Benzenoids are organic compounds which have benzene rings or multiple benzene rings together to form complex structure. Benzenoid compounds are classified in Monocyclic and Polycyclic aromatic compounds on basis of number of benzene ring.

Example of Monocyclic Aromatic Compounds:

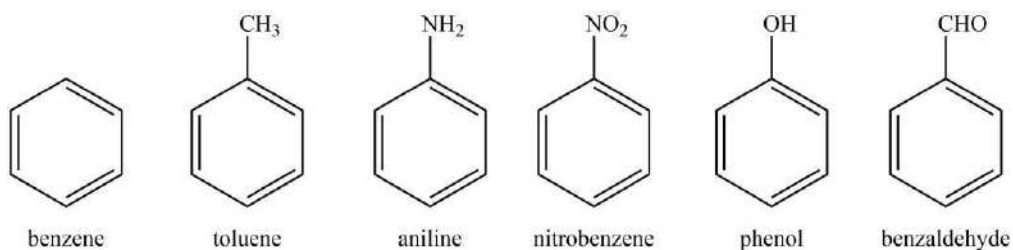

Example of Polycyclic aromatic compounds:

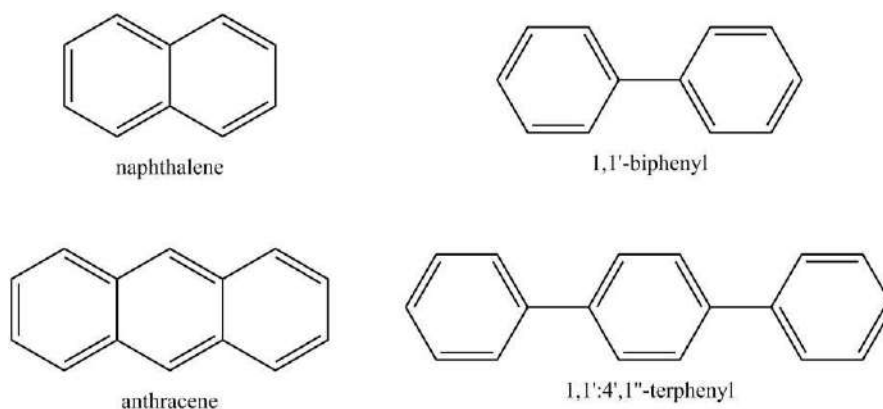

2. Non benzenoid compounds are compounds in which all carbons are in cycle or one or more heteroatom is present in the ring. These compounds are classified in two types Homocyclic and Heterocyclic aromatic compounds.

Example of Homocyclic aromatic compound



Example of Heterocyclic aromatic compound

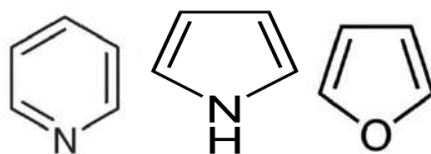

Pyridine

Pyrrole

Furan

9.4 Huckel's rule: or $(4n+2)\pi$ rule

Huckel in 1937 done the calculations for M.O. on monocyclic system. C_nH_n have n π -electrons and each carbon atom share one π -electron to provide aromatic stability or high delocalization energy or high resonance energy in a closed shell with $(4n+2)\pi$ electrons. Thus the aromatic compounds must contain 2π , 6π , 10π electrons for showing aromaticity. When $4n + 2$ rule is apply first counts total number of π electrons or lone pairs in the molecule, calculate this number by taking π electrons equal to $4n + 2$ to solves for n . The rule is only justify if n is 0 or positive integer (1, 2, 3, ...).

Condition for Aromaticity

1. Compound must contain $(4n+2)\pi$ -electrons.
2. Compound must contain planar ring because if ring is not planer overlapping of p-orbitals is absent.

Examples of Huckel's rule:

1. Benzene contain six π electrons, on applying the rule
 $4n + 2 = 6$ (Benzene has 6π electrons)
 $4n = 6 - 2$
 $4n = 4$
 $n = 1$ Integer value so compound is aromatic.

- Cyclopentadiene: Compound have 4 π electrons, follow Huckel rule when $n=1$.

Huckel's Rule for Aromatic Compounds (Number of Pi Electrons = $4n + 2$)

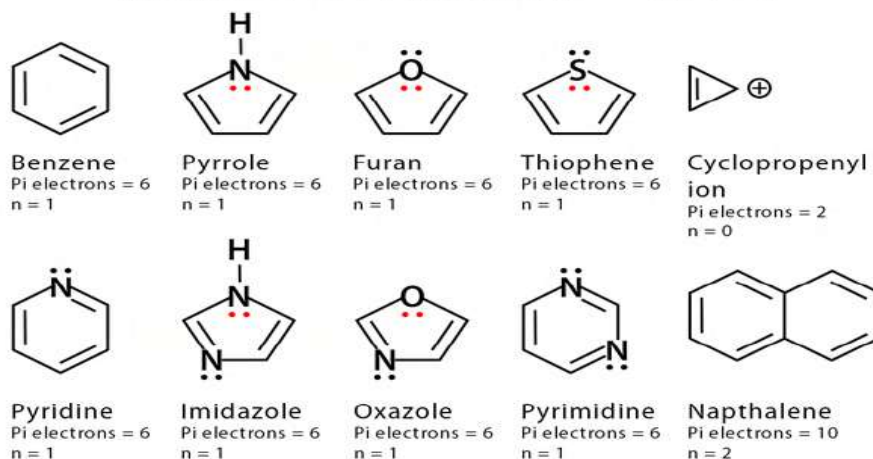

9.5 Huckel rule Exceptions

- Cyclobutadiene is a square shaped molecule follow Huckel's rule because it has 4 pi electrons but it is still unstable.
- Polycyclic Hydrocarbons: Huckel rule is not applicable for compounds have many rings. Example Pyrene have 16 pi electron and Coronene have 24 pi electrons, both the molecule are aromatic but does not follow $4n+2$ rule.
- Huckel's rule not followed by the compounds that contain higher number of pi electrons or greater than 20 pi electrons in polycyclic system.

9.6 Application of Huckel's rule

- To explain the aromaticity of non-benzenoid system.
- Explain the stability of Benzene
- Explain the stability of heterocyclic compounds like pyrrole, pyridine Furan etc.
- Stability of Monocyclic hydrocarbons
- Explain the stability of ions.

Summary

The chapter on aromaticity, benzenoids, and the Huckel rule explores the unique stability and properties exhibited by aromatic compounds. Aromaticity arises from the presence of fully conjugated pi-electron systems, and aromatic compounds must satisfy specific criteria,

including the Huckel rule, to be classified as aromatic. Benzenoids, including benzene and its derivatives, are examples of aromatic compounds commonly encountered in organic chemistry.

Keywords

Aromaticity: Property of certain cyclic compounds with a stable, delocalized π -electron system

Benzenoids: Aromatic compounds containing a benzene ring or similar structures with a planar, cyclic arrangement

MCQs

1. Which among the following compounds is considered a benzenoid?
 - a) Cyclohexane
 - b) Benzene
 - c) Ethanol
 - d) Methane

Answer: B

2. According to Hückel's rule, a cyclic molecule is aromatic if it contains how many π -electrons?
 - a) $4n+2 \pi$
 - b) $4n$
 - c) $2n$
 - d) $2n+12$

Answer: A

3. Which of the following compounds violates Hückel's rule for aromaticity?
 - a) Cyclobutadiene
 - b) Benzene
 - c) Cyclopentadiene
 - d) Pyrrole

Answer: A

4. Which property is commonly associated with aromatic compounds?

- a) High reactivity
- b) Low stability
- c) Planarity
- d) Lack of resonance stabilization

Answer: C

5. How many π -electrons does a molecule need to fulfil Hückel's rule for aromaticity if it contains three double bonds?

- a) 6
- b) 8
- c) 10
- d) 12

Answer: A

Self-assessment

1. Explain the concept of aromaticity in organic chemistry.
2. Provide an example of a benzenoid compound and describe its structural features.
3. Describe Hückel's rule and its significance in determining aromaticity.
4. Why does benzene adhere to Hückel's rule and exhibit aromatic properties?
5. Discuss the consequences of violating Hückel's rule for aromatic compounds.

UNIT - 10

Stereochemistry - I

Objectives

- Understand the principles of stereochemistry in organic molecules.
- Explore the conformational analysis of simple organic compounds such as ethane, butane, and cyclohexane.

10.1 Stereochemistry: Conformations structures of ethane, butane and cyclohexane

A single bond between two carbon atoms is created by the overlap of their sp^3 hybrid orbitals along the axis between the nuclei. This creates an electron distribution that is cylindrically symmetrical around the bond axis, allowing for almost free rotation. Consequently, this results in various temporary arrangements of atoms, known as conformations, rotational isomers, or rotamers.

10.2 Conformations of ethane

The ethane molecule the two methyl groups are linked by C-C sigma bond formed. In this ethane molecule if one CH_3 group is retained fixed and another CH_3 group is rotated around the C-C single bond, than immeasurable number of probable conformations of ethane are formed. The two most conformations of ethane are named as staggered & eclipsed and other all possible conformations are comes these are designated as Gauche and skew conformations. The conformations can be represented using Sawhorse and Newman projections.

(i) Sawhorse projection

In these projections, the central C-C bond is shown as a straight line, and the molecule is viewed from the side and slightly above the axis. The line is somewhat longer than usual. In these projections, the front carbon is depicted at the lower left, while the back carbon is at the upper right. Each carbon has three lines extending from it, representing three attached atoms or groups, such as Hydrogen atoms in ethane.

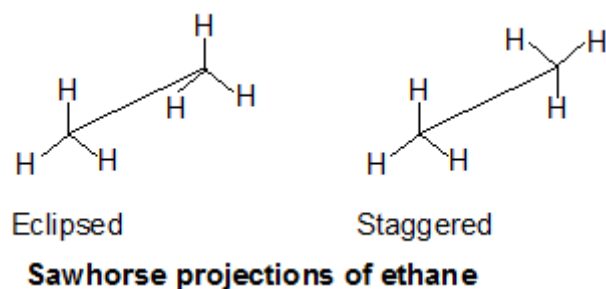

(ii) Newman projection

These projection formulas are created by looking along the bond connecting the two carbon atoms. The carbon atom closest to the viewer is represented by a point, with its three attached atoms or groups shown as three equally spaced lines. The carbon atom farther from the viewer is represented by a circle, with its three attached atoms or groups depicted as three evenly spaced lines extending from the circle.

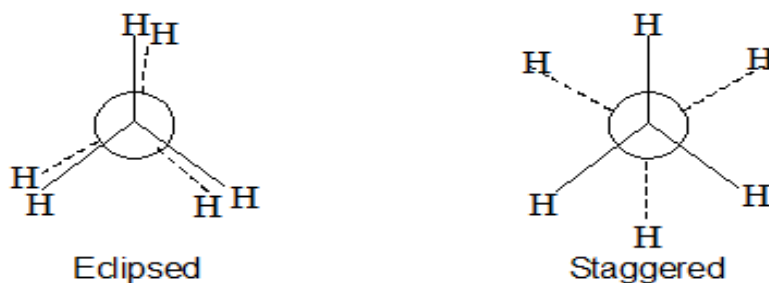

10.3 Conformations of n-butane

To study the conformations of n-butane, it is viewed as a derivative of ethane, where a methyl group replaces one Hydrogen atom on each carbon atom. The molecular structure of n-butane considered as dimethyl ethane as shown below,

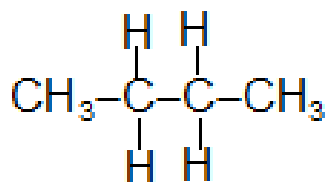

Thus, one methyl group and two hydrogen atoms are connected to both of the two centre carbon atoms (C_2 and C_3) in n-butane. The infinite number of conformations may form when one of the centred carbon atoms either C_2 or C_3 is fixed and other one is rotated by angle of 360° . Out of these conformers the six are most important and given below.

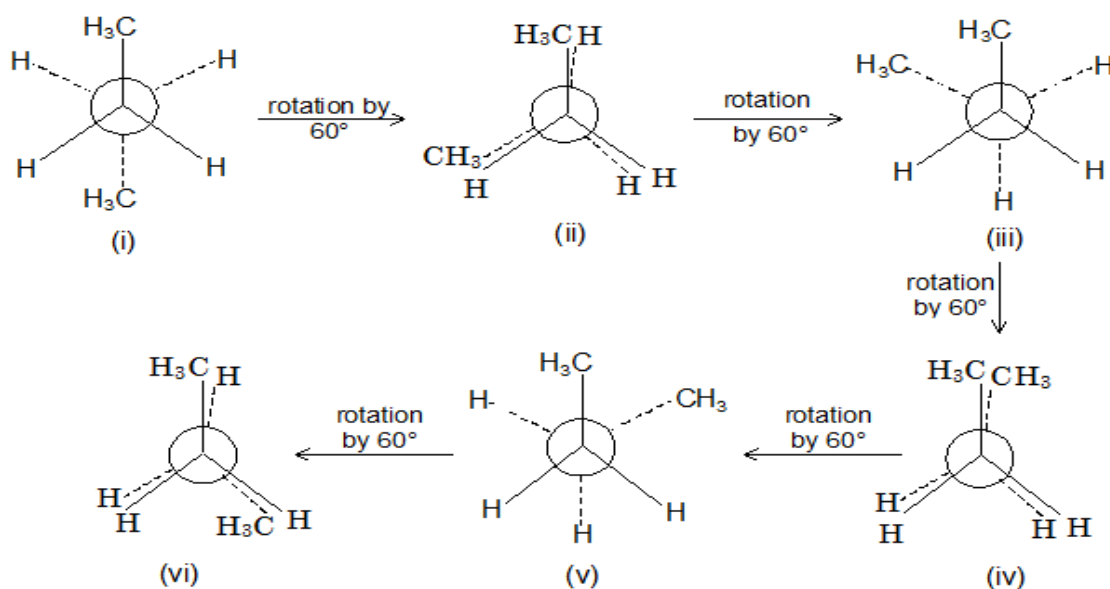

10.3.1 Relative stabilities of conformations

The anti-conformation (I) out of above listed six most conformation listed is the top most stable conformation and the two methyl groups which are non-bonded having dihedral angle 180° and the four hydrogen atoms which are non-bonded are sufficiently away from each other. After that the two the gauche conformation (III and V) that having the two non-bonded methyl groups that are just 60° far to each other and hence producing *crowding* or *steric strain*. Due to this steric strain these two gauche conformations (III and V) are somewhat less stable than the anti-conformation (I). Though, these two gauche conformations have the equivalent energy. It has been discovered through experimentally that the anti-conformation is approximately 3.35 kJ mol^{-1} more stable than the gauche conformation.

Next in terms of higher energy are the two partially eclipsed conformations (II and VI). In these conformations, the two CH_3 groups and a hydrogen atom on one carbon are positioned too close to a hydrogen atom on the other carbon, causing eclipsing interactions. Each methyl-hydrogen eclipsing interface introduces energy of 5.35 kJ mol^{-1} , hence the partially eclipsed conformations of n-butane (II and VI) are fewer stable as comparison to anti & gauche conformations. Though, these partially eclipsed conformations of n-butane are itself of equal energy. Experimentally, it has calculated that these partially eclipsed conformation (II and VI) is less stable than gauche conformations (III or V) by $10.85 \text{ kJ mol}^{-1}$ and then anti-conformation (I) by $14.2.2 \text{ kJ mol}^{-1}$.

The one fully eclipsed conformation (IV) is however, the less stable due to presence of one methyl-methyl eclipsing and two weak H-H eclipsing interactions. The totally eclipsed

conformation is approximately $18.4 - 25.5 \text{ kJ mol}^{-1}$ less stable than the most stable anti configuration, according to experimental results. Consequently, the relative energy of n-butane's four different conformations follows the sequence:

Anti > Gauche > Partially eclipsed > Fully eclipsed.

10.4 Conformations of Cyclohexane

Six-membered rings are common in natural cyclic compounds because they can adopt a nearly strain-free conformation known as the chair conformation. In this chair form, all bond angles in cyclohexane are 111° , which is very close to the ideal tetrahedral angle of 109.5° . Moreover, all adjacent bonds are staggered.

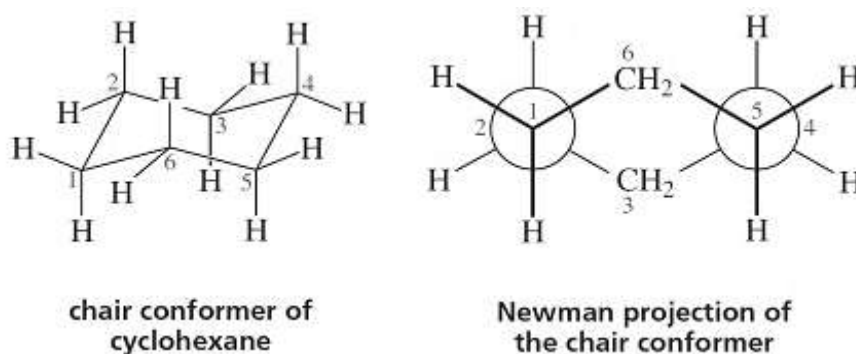

In the chair form each of carbon has axial and equatorial bonds. Alternating above and below the ring, the axial bonds are vertical. Among the highest carbons, the axial bond is up on one, down on the next, up on the next, and so forth. Outward from the ring are the equatorial bonds. The reason for the equatorial bonds' tilt is because the bond angles exceed 90° . The equatorial bond on the identical carbon is slanted downward if the axial bond is pointing up. The equatorial bond on the same carbon is slanted downwards if the axial bond is pointing down.

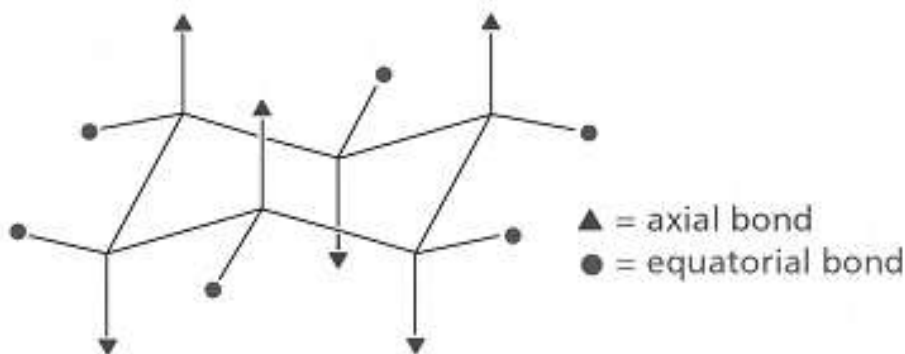

Cyclohexane can also adopt a boat conformation, which, like the chair conformation, is free from angle strain. However, the boat conformation is less stable due to torsional strain from some eclipsed bonds. The near closeness of the flagpole hydrogens, or the hydrogens in the

"bow" and "stern" of the boat, further destabilizes the boat conformer and results in steric strain.

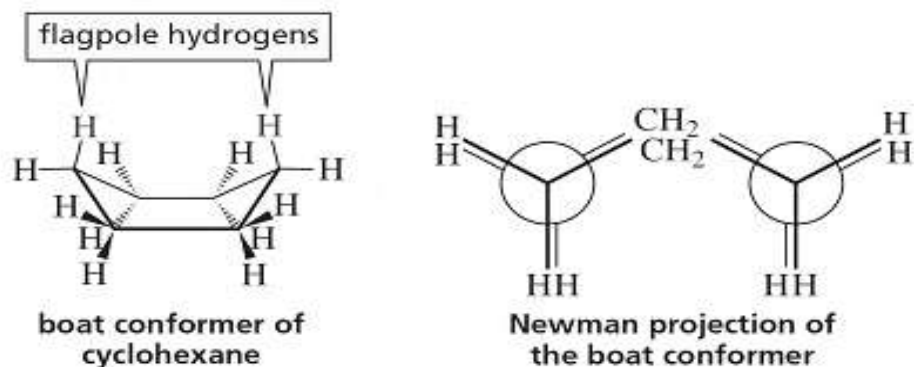

The convenience with which cyclohexane can rotate around its carbon-carbon bonds allows it to interconvert between two stable chair conformations rapidly and this interconversion known as ring flipping. During this ring flipping between these two chair conformers the equatorial bond of one chair become axial in other chair conformers and vice versa.

The conformation that cyclohexane can adopt when interconverting from one chair conformer to the other. One of the topmost carbons of the boat conformer should be dragged down to become the bottommost carbon in order for it to change from the boat conformer to one of the chair conformers. The twist-boat (or skew-boat) conformer is acquired by applying a small downward force on the carbon. The twist-boat conformer exhibits greater stability compared to the boat conformer due to reduced eclipsing, which reduces torsional strain, and the flagpole hydrogens moving apart, which alleviates some of the steric strain. In comparison to the boat conformer, the twist-boat conformer is more stable because to less eclipsing, which lessens torsional strain, and the flagpole hydrogens moving away, which lessens some steric strain.

The energy barrier for interconversion is about $12.1 \text{ kcal mol}^{-1}$ (50.6 kJ mol^{-1}) and the graph illustrates the energy of a cyclohexane molecule as it interconverts from one chair conformer to another. This number can be used to calculate the rate at which cyclohexane flips rings at room temperature-105 times per second. To put it another way, the two chair conformers are rapidly reaching equilibrium.

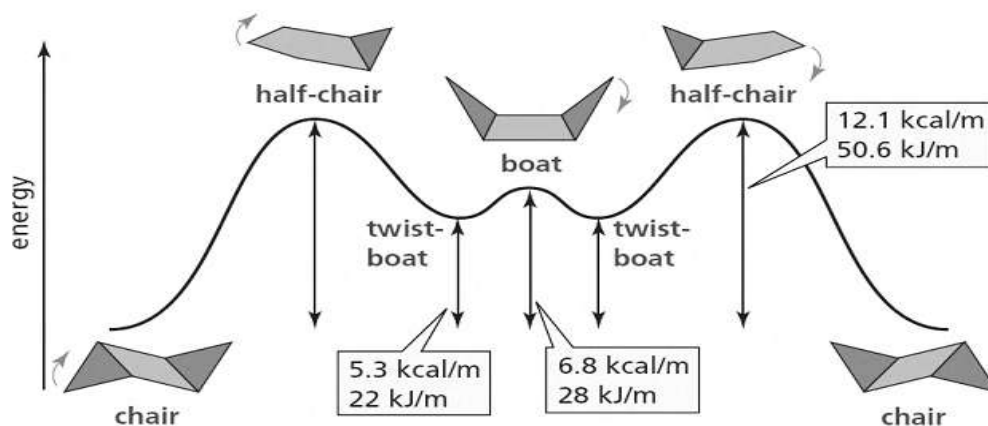

At any given time, there are far more cyclohexane molecules in chair conformations than in any other conformation because chair conformers are more stable conformers. It has been determined that, out each thousand cyclohexane molecules in a chair conformation, the next most stable shape, the twist-boat, contains little more than two molecules.

A monosubstituted cyclohexane, like methylcyclohexane, has two chair conformers that are not equivalent, in contrast to cyclohexane, which has two equivalent chair conformers. In other words, despite the fact that a substituent experiences less steric hindrance when it occupies an equatorial position in a chair conformation, the stability of the conformation is not solely determined by steric interactions. Other factors, such as the stability of the substituent's neighboring groups and the overall conformational strain of the molecule, also play crucial roles. For instance, in the case of a methyl substituent, placing it in an equatorial position might offer less steric hindrance, but it might also introduce destabilizing interactions with other substituents or functional groups. Therefore, the overall stability of the molecule is determined by a balance of various factors.

Summary

Stereochemistry deals with the arrangement of atoms in molecules and its effect on their properties and reactivity. Conformational analysis involves studying the different spatial arrangements of atoms in molecules, especially with regard to rotation about single bonds. For simple organic compounds like ethane, butane, and cyclohexane, various conformations can be analyzed to understand their stability and energy profiles.

Keywords

Conformation: Different spatial arrangements of atoms in a molecule due to rotation around single bonds.

Cyclohexane: A six-membered cyclic hydrocarbon with the molecular formula C_6H_{12}

MCQs

1. Which of the following statements about cyclohexane is correct?
 - a) Cyclohexane exists only in the chair conformation.
 - b) The boat conformation of cyclohexane is more stable than the chair conformation.
 - c) Cyclohexane can undergo ring flipping to interconvert between chair conformations.
 - d) Cyclohexane does not exhibit any conformational isomerism.

Answer: C

2. Which of the following represents the most stable conformation of cyclohexane?
 - a) Chair
 - b) Boat
 - c) Twist-boat
 - d) Half-chair

Answer: A

Self-assessment

1. Explain the concept of conformational analysis with respect to ethane.
2. Discuss the importance of interconversion between different conformations in understanding the behaviour of organic molecules.
3. Describe the factors that influence the stability of the chair conformation in cyclohexane.
4. Explain the role of steric hindrance in determining the preferred conformation of organic molecules.
5. Compare and contrast the various conformations of butane in terms of their steric hindrance and stability

UNIT – 11

Stereochemistry – II

Objectives

- Learn about different methods of representing molecular conformations.
- Understand wedge formula.
- Understand Newman projection, sawhorse projection and Fischer projection

11.1 Interconversion of Projection Formula

To understand the stereochemical aspects of reaction it is necessary to use relationship between different projections of organic compounds. One projection formula is changes to another without any change in configuration by following formula.

11.1.1 Fischer Projection to Sawhorse Projection

- First making an eclipsed form which is then rotate 180° around C_2-C_3 bond.
Example conversion of Fischer projection to Sawhorse projection for tartaric acid is.

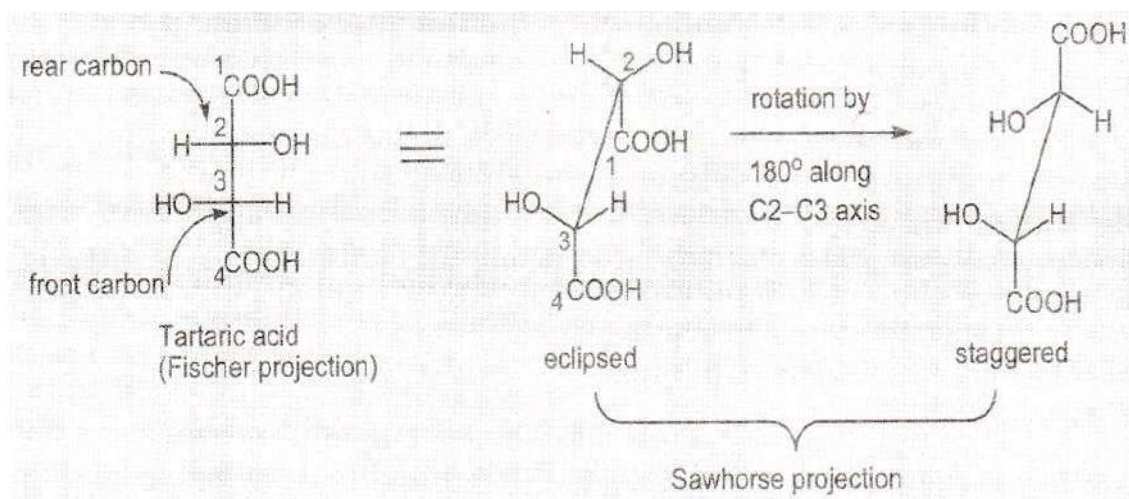

- Fischer Projection to Sawhorse Projection by Newman Projection

The molecule present to lowest chiral carbon is becomes the front carbon and drawn eclipsed Newman projection. Than rotation of front carbon by 180° gives staggered conformation. At last viewed molecule from the central bond to draw sawhorse projection is draw.

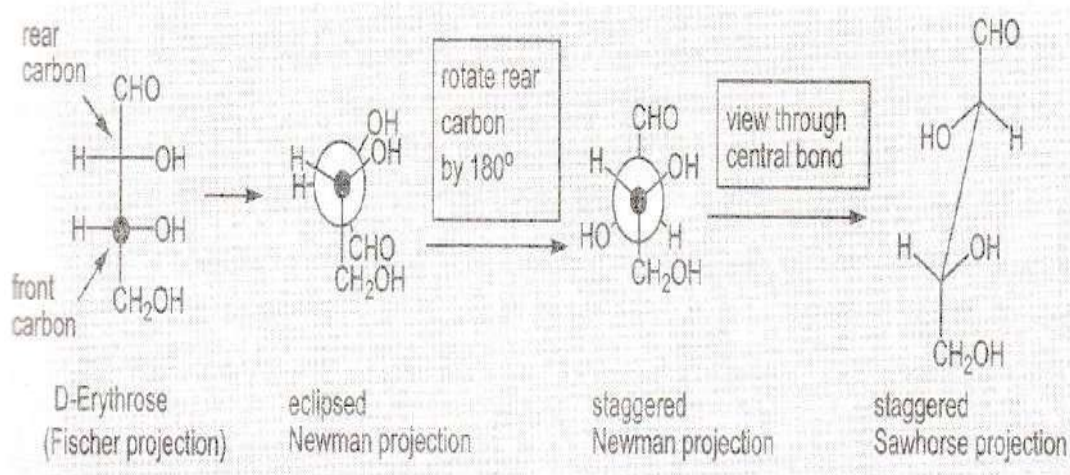

11.1.2 Sawhorse Projection to Fischer Projection

- In first step the staggered Sawhorse projection is changes to eclipsed projection. It is done in vertical plane that the two groups comes away from the viewer those are pointing upwards that is both these groups present in the vertical line.
- Changes of Sawhorse Projection Formula to Fischer Projection by Newman Projection. For conversion of Sawhorse projection to Newman projection its required to the molecule is viewed from the front carbon that central C-C bond being invisible, to form staggered Newman projection. Then rotate the front carbon along the central bond by 180o to form eclipsed Newman projection. Then, the molecule is held in the vertical plane, i.e. keeping front carbon as the lowest carbon) to get the Fischer Projection.

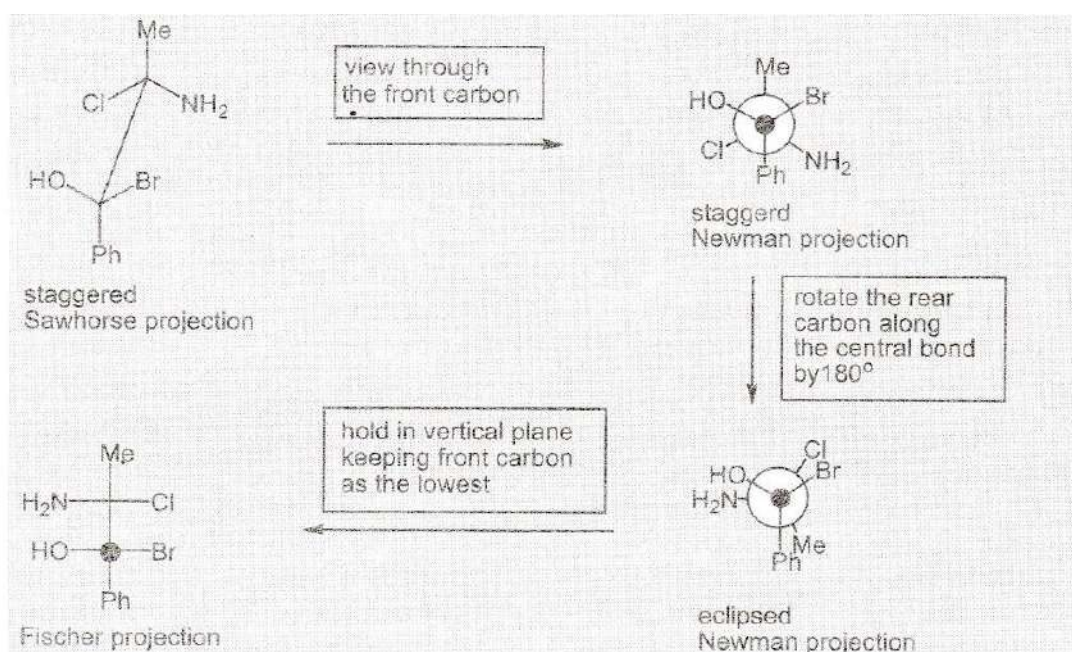

11.2 Fischer Projection to Flying Wedge Projection

In the Fischer projection vertical bonds are drawn in the plane by a simple line and horizontal bonds are present above and below the plane.

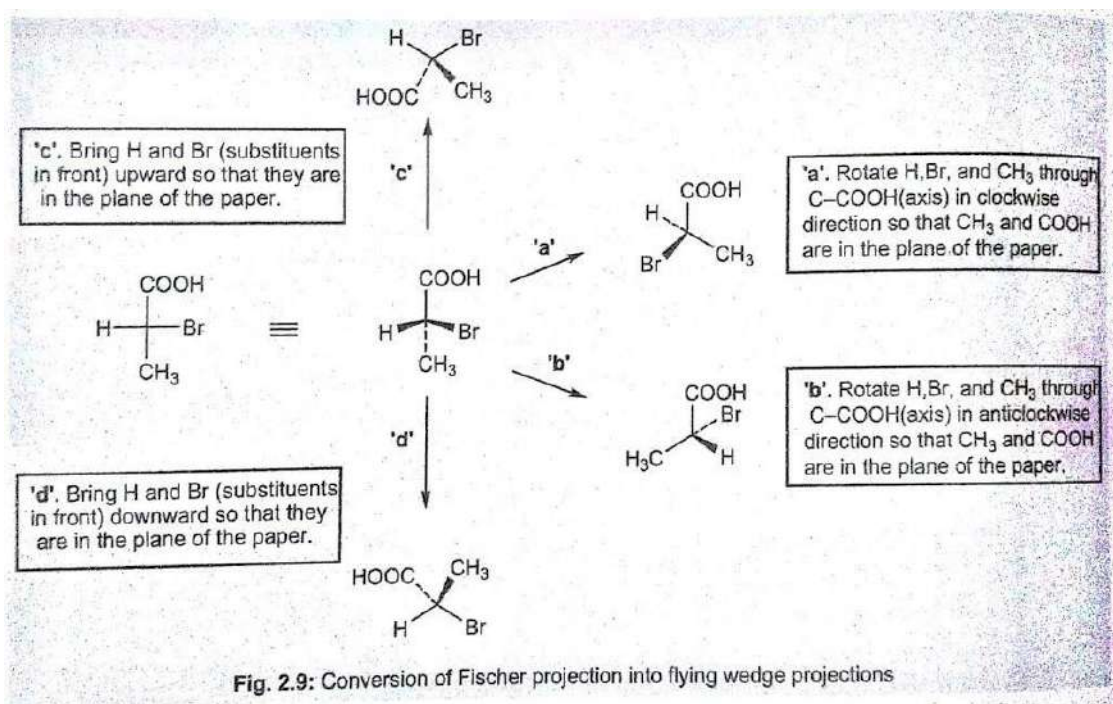

12 Flying Wedge Projection to Fischer Projection

Molecule is rotated as in such a way that highest priority group is away from the viewer (in the vertical plane) and lowest priority group is pointed out towards the viewer.

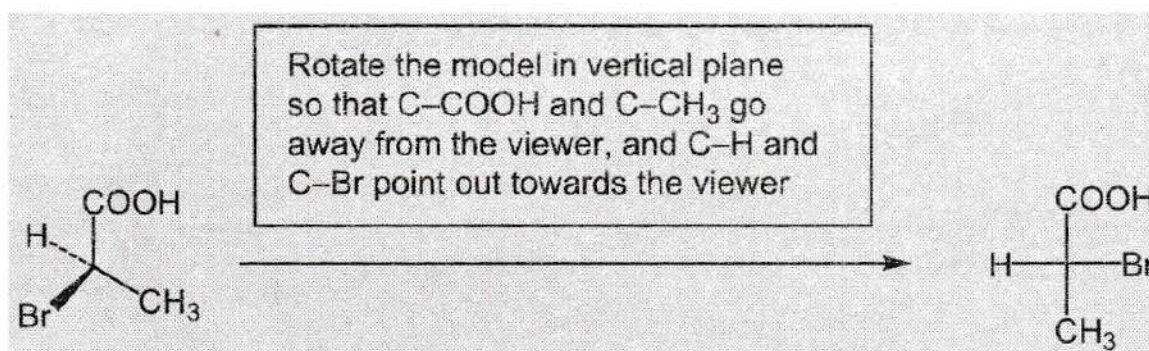

Summary

Different methods are used to represent molecular conformations, including wedge formula, Newman projection, sawhorse projection, and Fischer projection, each offering unique advantages in visualizing molecular geometry.

Keywords

Wedge formula: A representation of a molecule in which solid wedges indicate bonds projecting .

Newman projection: A method of representing the conformation of a molecule by viewing it along a specific bond axis,

Sawhorse projection: A type of molecular representation that shows the relative orientation of atoms in a molecule

MCQs

1. Which projection is commonly used to represent the spatial arrangement of atoms in a molecule when viewed from the side?
 - a) Fischer projection
 - b) Newman projection
 - c) Sawhorse projection
 - d) Wedge formula

Answer: B

2. Horizontal lines represent what in a Fischer projection
 - a) Projecting out of the plane of the paper.
 - b) Projecting behind the plane of the paper.
 - c) Within the plane of the paper.
 - d) None of the above.

Answer: A

3. In the Newman projection of butane, the most stable conformation is:
 - a) Staggered anti
 - b) Staggered gauche
 - c) Eclipsed
 - d) Anti-periplanar

Answer: A

4. Which type of projection is often used to represent the conformation of cyclohexane?
 - a) Fischer projection
 - b) Newman projection

- c) Sawhorse projection
- d) Wedge formula

Answer: C

Self-assessment

1. Compare and contrast the wedge formula, Newman projection, Sawhorse projection, and Fischer projection methods for representing molecular conformations.
2. Explain how the wedge formula and Fischer projection methods differ in representing the stereochemistry of organic molecules.
3. Discuss the significance of the Newman projection in analyzing the conformational stability of organic compounds.

UNIT – 12

Stereochemistry - III

Objectives

- Gain insight into the concept of chirality and its significance in organic chemistry.
- Study the types of stereoisomerism, including geometrical isomerism and optical isomerism.
- Learn about enantiomers, diastereomers, and meso compounds and their characteristics.
- Understand the threo and erythro, D/L and cis-trans nomenclature nomenclature and its application in describing diastereomers.
- Learn about the Cahn-Ingold-Prelog (CIP) rules for assigning R/S configurations to chiral centers and E/Z nomenclature for describing double bond configurations.

12.1 Chirality and Stereoisomers

Stereoisomers are the type of isomerism where the spatial arrangement of atoms or groups is different but connectivity of atom is same in all isomers. The mirror-image stereoisomers also known as enantiomers are the most interesting type of isomer are mirror image of one another and non-superimposable on each other. The concept of chirality determines the existence of these compounds.

Organic moieties constructed with a carbon skeleton play a crucial part in the life of chemical science. Organic compounds are significant because of the energy they contain, mainly in the form of potential energy. It is critical to understand the idea of an isomer, which is a molecule with the same atomic composition but a different in skeleton layout, by changing the atomic positioning there is substantial impact on the potential force. This section will focus on the chirality of a particular type of isomer known as a stereoisomer.

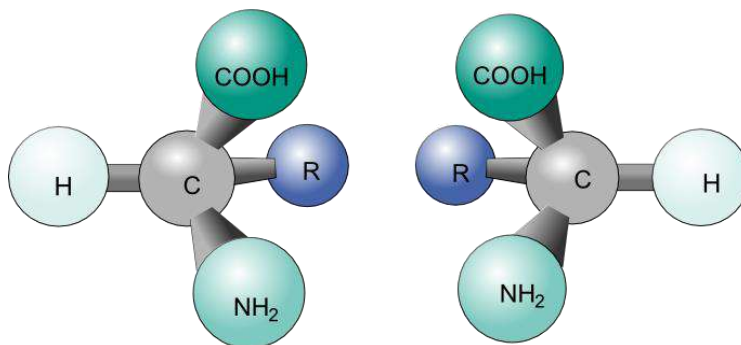

Figure 12.1 Two enantiomeric form of a Tetrahedral Molecule.

In today chemistry, the concept of ‘chirality’ and ‘stereoisomerism’ are immensely vital because they afford a ‘theoretical’ and ‘physical’ foundation for knowing the construction and structures of many different organic substances. Generally, ‘stereoisomerism’ preserves similar atomic networks and ordering of constructing blocks along with having equal numbers of atoms and kinds of elements. This is in dissimilar to the ‘constitutional’ isomerism, which builds isotopic composites solely *via* altering the connectivity of atoms.

12.2 Enantiomers

Enantiomers are any two substances that are interconnected to each other in the similar way that the right hand is related to the left, *i.e.*, as mirror images that are irreversibly opposed to one another. Hence, the enantiomer is a couple of ‘stereoisomers’ which are non *superimposable* mirror images of each other’s. Figure-12.2, represents the critical example (the gray plane in mid is the mirror plane).

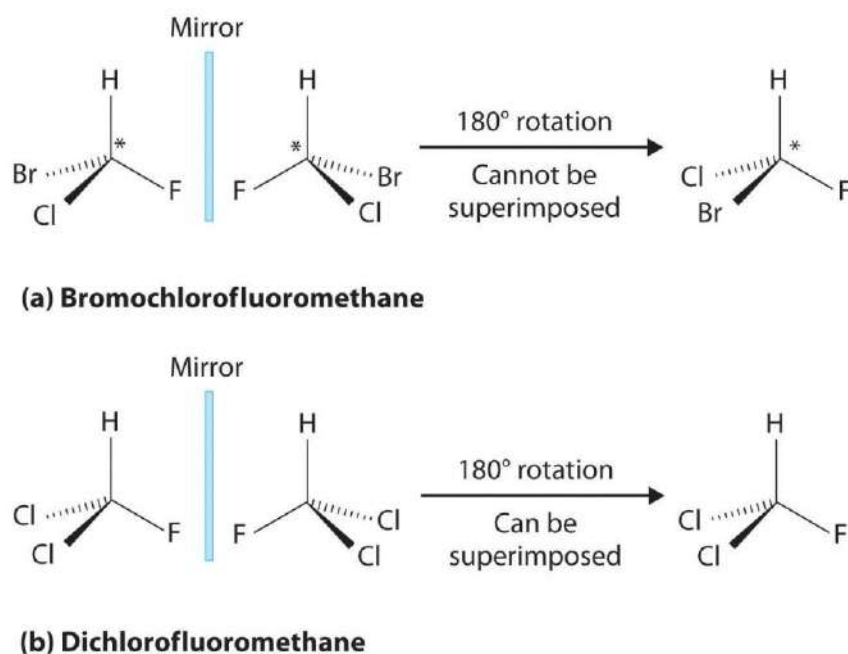

Figure 12.2: (a) Chiral molecule bromo-chloro-fluoromethane having one stereocenter marked with (*). By rotating its mirror image original structure not obtained. (b) Achiral molecule dichloro-fluoro-methane and its mirror image are superimposable and the all rotated images are also superimposable to each other.

12.3 Chirality

Chiral compounds are defined as those that exist as enantiomers and form non-superimposable mirror images. A plane of symmetry can't exist in a chiral molecule. The

symmetry plane is a plane that splits a thing, in this case a molecular structure, so that the two halves are mirror images of each other. A cylinder is an illustration of a structure with a plane of symmetry. When a cylinder is cut in half lengthwise, two identical mirror-image halves are produced. Any conformation that a molecule has a ‘**plane of symmetry**’ in makes it identical to its mirror copy. These kinds of molecules called non-chiral, or achiral. Unlike 2’bromo-butane, which is chiral, butane is an achiral molecule (Figure 12.3).

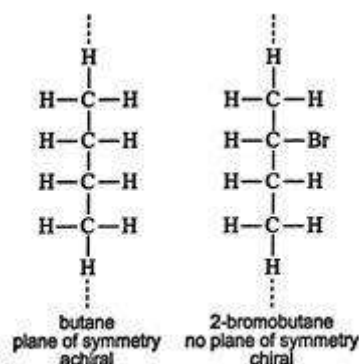
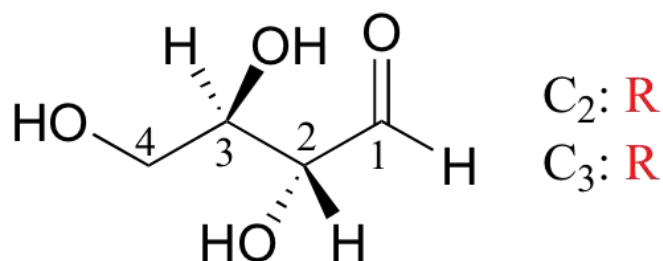

Figure 12.3 : Example of Achiral and chiral molecule

Generally speaking, no molecule that has diverse surrounding atoms is achiral. Chirality is a basic yet crucial notion that explains one kind of stereoisomerism and is used to support the idea of stereoisomerism. The impact of chirality in today organic chemistry can be found in the differences between the chemical characteristics of a chiral molecule and its mirror counterpart.

12.3.1 Compounds with Multiple Chiral Centre

Next, we focus on molecules that possess several stereocenters and in this category we will discuss the stereochemistry of sugar D-erythrose made by four carbons.



D-erythrose

The D/L notation mention the different sugars, however, we won't stress about knowing the system.

The ‘D-erythrose’ is a Chiral moiety having two C₂ and C₃ as stereocenters, both of these chiral carbons having the R configuration. Now the question is that does the D-erythrose have an enantiomer then answer is yes since it is a Chiral molecule. The mirror image of ‘D-erythrose’ enantiomer is ‘L-erythrose’ and both of these are not superimposable (Figure 12.4). Here, it is noted that in the ‘L-erythrose’ both chiral carbons have S configuration and enantiomeric partner of the entire Chiral centres contain the ‘opposite configuration’.

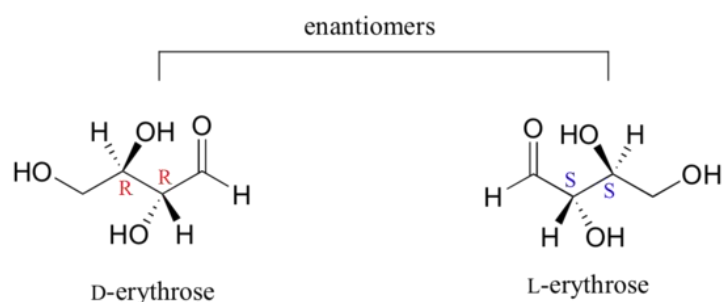

Figure 12.4: Pictorial presentation of enantiomers of erythrose.

If we sketch a stereoisomer of Erythrose sugar have the S configuration at C₂ carbon and R configuration at C₃ carbon, what would happen? This stereoisomer of sugar is named as ‘D-threose’ and this isomer is not a mirror image of sugar Erythrose. ‘D-threose’ is a diastereomer of both ‘D-erythrose’ and ‘L-erythrose’ (Figure 12.5).

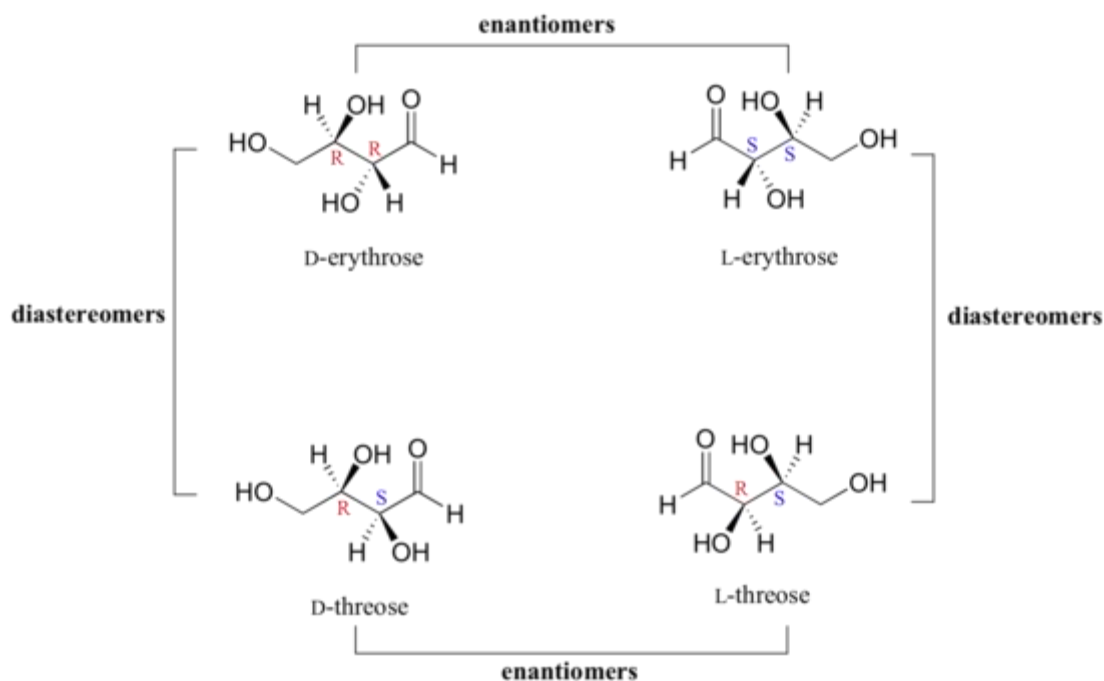

Figure 12.5 : Enantiomers and diastereomers of erythrose

Diastereomers are defined simply: two molecules are diastereomers by default if they are stereo-isomers (as they have similar molecular formula, connectivity and not have similar spatial connectivity) but not are enantiomer of each other. *Practically speaking, this indicates*

that in a pair of diastereomers, at least one chiral centre is opposing, but not all of them. Hence, we can conclude that the two molecules those are diastereoisomers defiantly they not mirror images of one another.

‘**L-threose**’, that is enantiomer of ‘**D-threose**’, containing the *R* configuration at C2 and it C3 carbon has the *S* configuration. Hence the sugar ‘L-threose’ also is a *Diastereoisomer* of both ‘Erythrose’ enantiomers.

The structure with *n* number of stereo-centres will often have 2^n distinct stereoisomers. As an illustration, let's look at the open-chain form of the glucose molecule (as the many sugar molecules can found in open-chain as well as cyclic forms). ‘**D-glucose**’ and ‘**L-glucose**’ are two enantiomeric forms of glucose. The D enantiomeric form of glucose is sugar that our bodies consume for production of energy. For the glucose $n = 4$ and according ($2^n = 2^4 = 16$) sixteen potential stereoisomers are possible with including ‘D-glucose’.

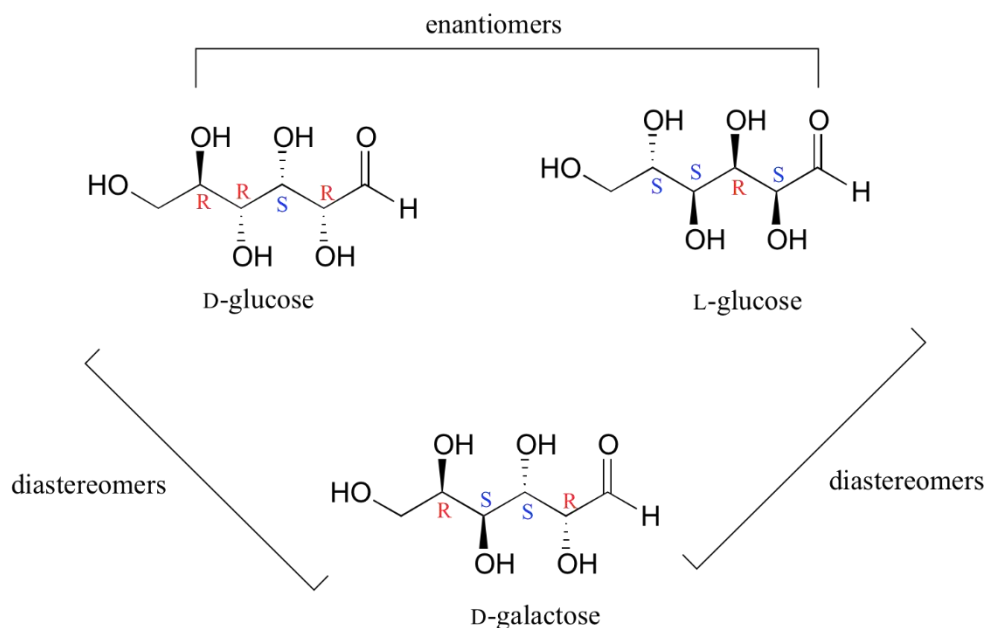

Compared to ‘D-glucose’, all of the stereo-centers in ‘L-glucose’ are inverted. There are now 14 D-glucose diastereomers, which are molecules with at least one, but not all, of their stereo-centers inverted with respect to ‘D-glucose’. Above is a picture of ‘D-galactose’, one of these 14 diastereomers: One of the four stereocenters of ‘D-galactose’ is reversed in comparison to ‘D-glucose’. Epimers are stereoisomers that differ in just one stereo-center (as opposed to two or more). Thus, in addition to existence as diastereomers, ‘D-glucose’ and ‘D-galactose’ can also be referred to as epimers.

12.4 Element of Symmetry

An object if having one and additional chiral centers it might be achiral or chiral depends whether it has “element of symmetry” or not. If a molecule have either Plane of symmetry; Centre of symmetry; Alternative axis of symmetry is achiral.

12.4.1 Plane of Symmetry

When an object can be superimposed on its mirror image, it means that it is optically inactive since it cannot rotate plane polarized light. An item has a plane of symmetry if it can be divided exactly in half, such that each half is a mirror image of the other.

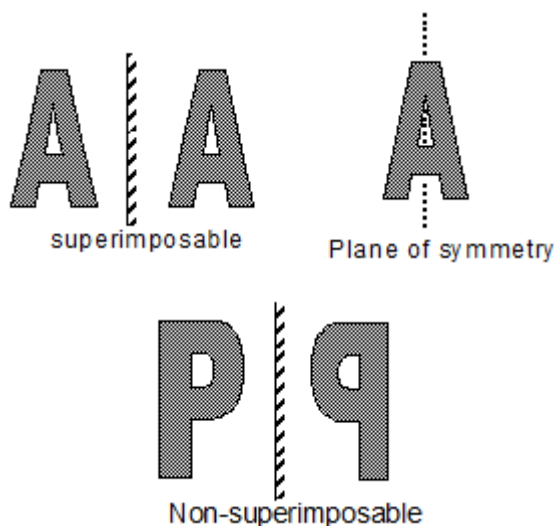

12.4.2 Centre of Symmetry: It is a location inside a molecule from which one needs an equal amount of time to travel an equal distance in both directions.

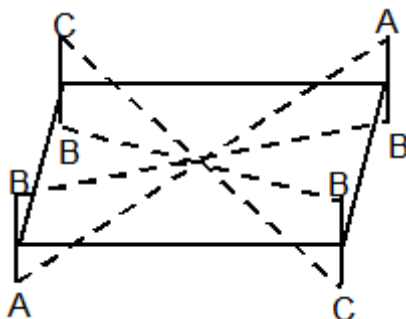

An organic molecule is thus optically inactive, superimposable on its mirror-image, and unable to rotate plane polarized light if it has greater than one chiral carbons and any amount of symmetry. A molecule is considered chiral if it has several chiral centres without any symmetry elements.

Stereoisomerism in 2,3-dibromo-pentane.

The chemical structural in 2,3-dibromo-pentane is

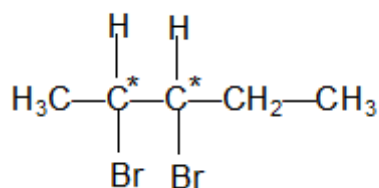

This chemical moiety comprises two *Chiral* carbons and applying “Van't Hoff rule” the entire number of ‘optical isomers’ should be $2^n = 2^2 = 4$ and these ‘**four optical isomers**’ are as.

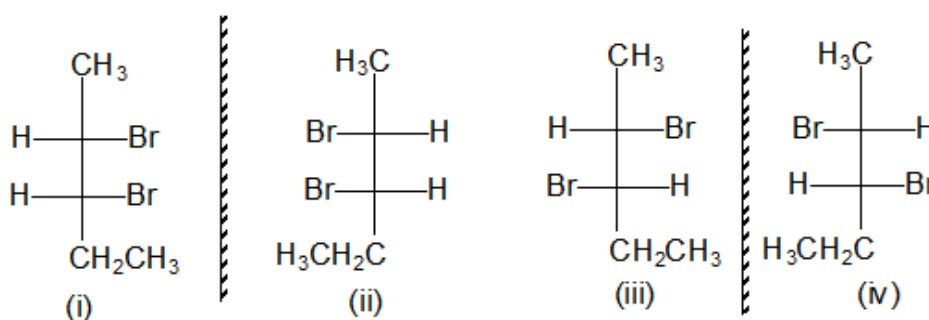

I, II, III and IV are the four count stereoisomers of 2,3-dibromo-pentane.

I and II are the ‘enantiomers’. III and IV are the also ‘enantiomers’.

Now what is the connection between I and III or I and IV or II and III or II and IV?

All these are diastereomers as the stereoisomers which are not mirror image is known as the “Diastereomers”.

Consequently,

I and III-‘Diastereomers’

I and IV-‘Diastereomers’

II and III -‘Diastereomers’

II and IV-‘Diastereomers’

Stereo-isomerism in Tartaric acid

The IUPAC nomenclature of **tartaric acid** is “2,3-dihydroxy butandioic acid”.

The **tartaric acid** have 2 ‘Chiral Carbons’ and the total ‘optical isomers’ should be $2^n = 2^2 = 4$, never the less, it has 3 optical isomers, since one isomer contains plane of symmetry.

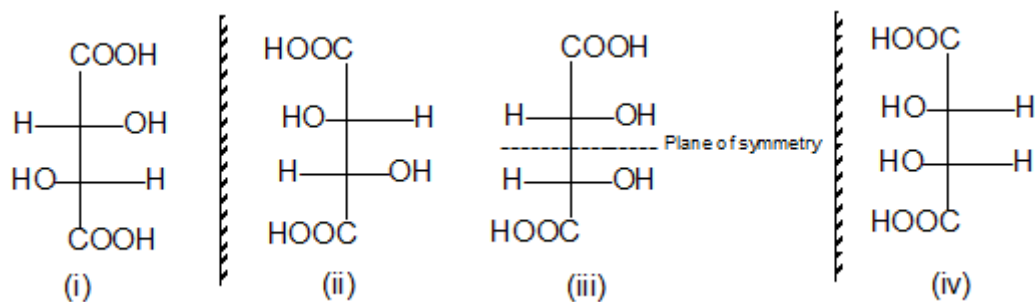

(III) ;(IV)both are same.

After rotation (IV) by 180° gives(III).

(I);(II)both 'enantiomer'

III isomer is 'meso' isomer of title compound.

'Meso' compound having single chiral carbon but '**optically inactive**' due presence of plane of symmetry.

Difference between '*Racemic Mixture*' and '*Meso Compound*'

Equimolar concentrations of enantiomers can be found in a racemic combination. Its external adjustment makes it optically inactive. It breaks down into forms that are optically active. Because of internal correction, a meso compound is optically inactive.

12.5 Optically active compounds having no Chiral Carbon

When the chemical molecules having two or more 'chiral carbon' atoms are superimposable on their mirror counterparts and consequently '*optically inactive*', the existence of chiral carbon is a not sufficient requirement for 'optical activity'. Alternatively, optical activity can occur in molecules without '*Chiral carbon*'.

- (i) If any molecule containing the atom other than carbon with different four bonds having to the corners of a 'tetrahedron' will be '*optically active*' for example S atom in following molecule.

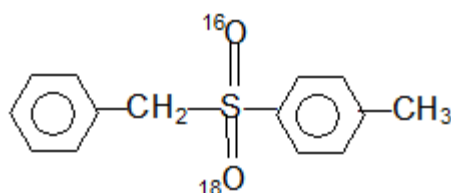

- (ii) Pyramidal bonded atoms should be expected to produce optical activity if they are bonded to three distinct groups because an '*unshared pair of electrons*' is comparable to a 4th group or atom for example in ammonia nitrogen atom shows optical activity.

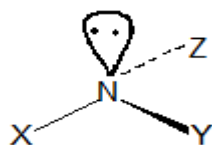

These substances have been the subject of numerous efforts at solves, but until quite recently, umbrella effect, also known as pyramidal inversion, has caused all of them to fail. The ‘*unshared pair*’ rapidly oscillates from one side of the X-Y-Z plane to the other, causing the umbrella effect.

- (iii) Biphenyls, having four huge groups in the ortho location consequently here is restriction of rotation occur, optically activity is found these asymmetrical biphenyls.

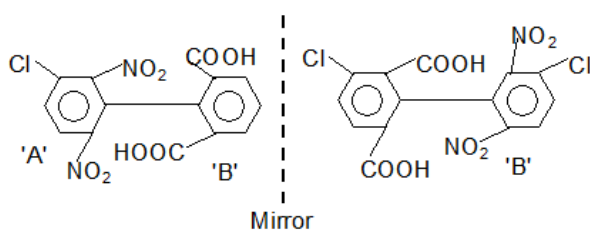

Ring B is symmetrical (having plane of symmetry) superimposable optically inactive.

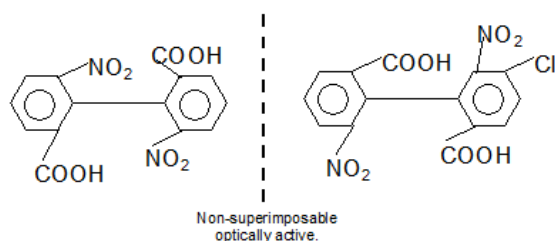

Allenes having even number of “cumulative double bonds” and both sides not having the same substituents are optically active.

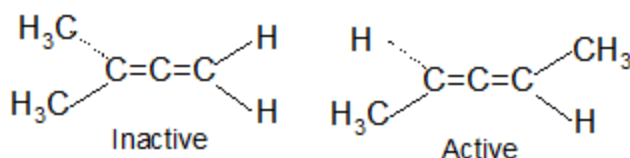

Specific-Rotation

The Specific-rotation $[\alpha]$ is a characteristic physical property of an enantiomers, which differs with used solvent, Temp (in °C) and wave-length of the light used. It is intended from the experiential rotation as follows.

$$[\alpha] = \alpha / l \times c$$

Here l = Length of tube decimetres (dm)

C = Concentration in gram cm^{-3} , for a solution density in gcm^{-3} , for a pure liquids

12.6 Erythro and Threo Isomers

In stereochemistry, the phrases erythro and threo are frequently used to refer to substances that have two stereogenic centres. Since the saccharides erythrose and threose are the source of the names, let's sketch their Fischer projection to get the meaning behind this notation:

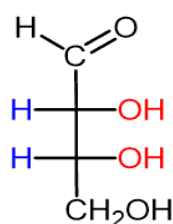

Erythrose

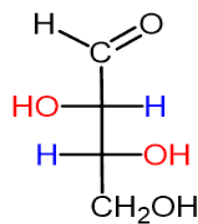

Threose

Two H's on the same side

Two H's on opposite sides

Two OH's on the same side

Two OH's on opposite sides

When the two groups on stereogenic centres the groups are in same side in as in the given example the H and OH, are in same side it refer the sugar is **erythrose** and **threose** if are present in **opposite sides**. D and L enantiomers are the names given to the two enantiomeric versions of erythrose and fructose.

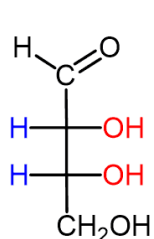

D-erythrose

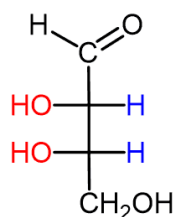

L-erythrose

enantiomers

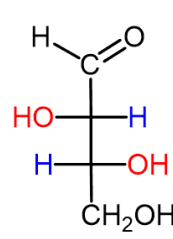

D-threose

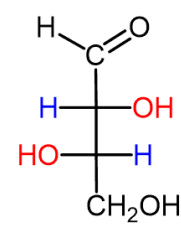

L-threose

enantiomers

For instance, the halide below is referred to as erythro when the Cl and Br are on the same side of the adjacent carbon atoms and threo when they are on the other side:

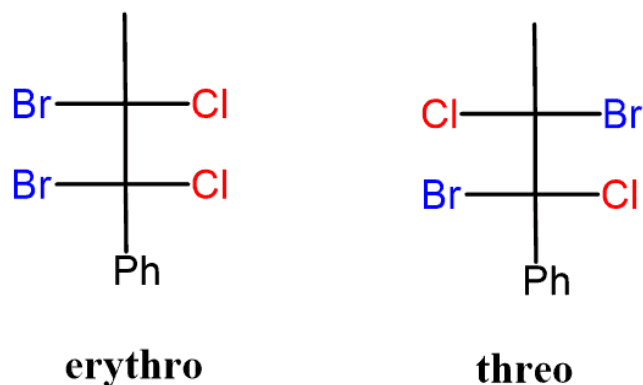

Sawhorse projections may also show erythro or threo arrangements. The erythro arrangement is possible if the two identical groups on both the chiral centres can be eclipsed.

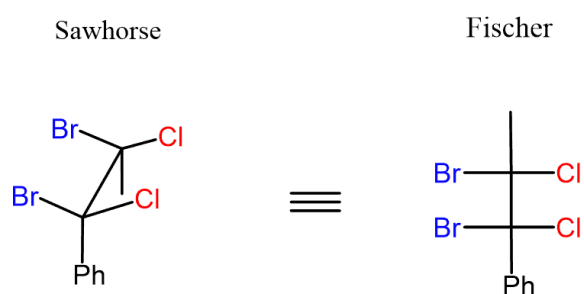

An erythro isomer

12.7 Cis-Trans Isomerism: Properties and Limitations

In the chemistry there are two of isomerism named as structural and stereoisomerism. The structural stereoisomerism is again divided in positional, functional, group and chain isomerisms. The stereoisomerism is divided into conformational and configurational, optical and geometric isomerisms. Cis-Trans stereoisomerism is also called as **Geometric Isomerism** and this type isomerism is found in both organic and inorganic compounds. In this case the configuration of attached functional atom or group in space is differing.

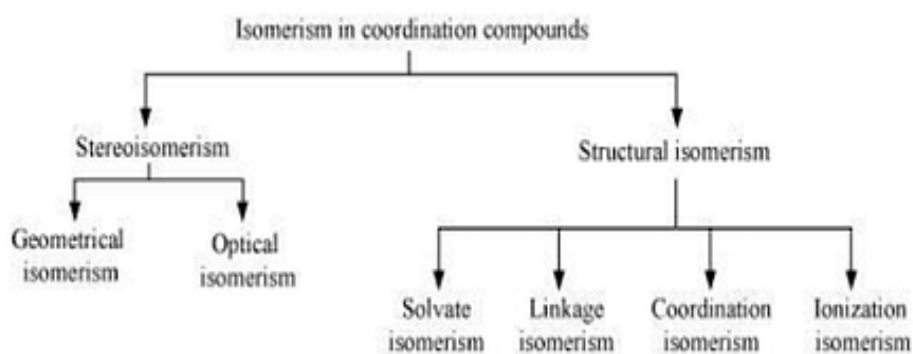

Examples of Cis-Trans Isomerism.

The following compounds shows the cis-trans isomerism

- (i) Alkenes and other compounds those containing C=C.
- (ii) Cyclic alkanes.

When the two identical groups in C=C bond are located in same side in space the isomer have **Cis** geometry and in other case if the identical groups are in opposite sides in space the geometry of isomer is refer as **TrAnswer**. In the compounds with double bonds between both carbons is restricted for free rotation that possible in single bonded carbons.



Cis Trans

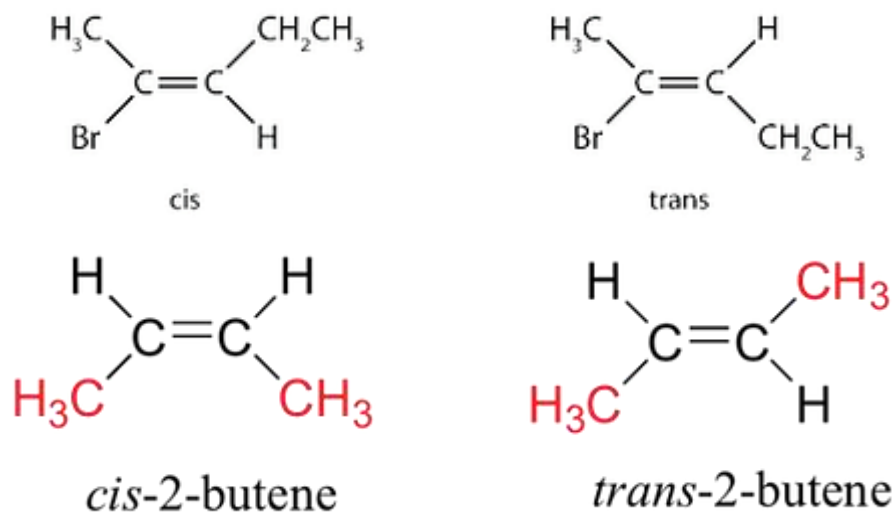

12.7.1 Limitations of Cis- Trans Isomerism

When the both bonded carbons of double bond have the non-identical functional groups as in $\text{bdC}=\text{Cac}$ the cis-trans isomerism is not possible because there is no two identical groups on both carbons. For example in flowing compound are not shows the cis-trans isomerism.

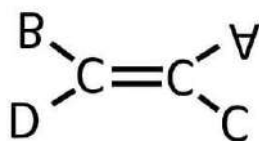

Cis-trans isomerism in inorganic compounds

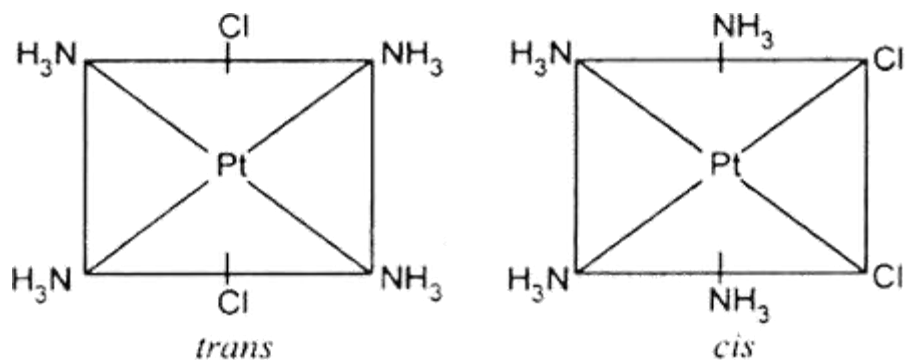

Point for remember:

Because alkenes have atoms that are limited and have distinct functional groups on their own, they display cis-trans isomerism. Trans form of isomer are more stable than comparison to cis isomer as the trans isomer are non-polar in nature and having higher boiling point..

12.8 R/S Nomenclature

Cahn, Ingold and Prelog were given the concept of R/S nomenclature following four rules were suggested to decide the priorities of the different substituents attached with a symmetric centre (Sequence Rule). The several enantiomers of chiral substances are named using the R/S nomenclature, also known as the right hand and left hand nomenclature. The chiral compound's substituents are called in the following order: 1, 2, 3,... From the most important substituent to the least important, an arrow is drawn. The stereo centre is designated R (Rectus) if the arrow is pointing clockwise and S (Sinister) if it is pointing counter clockwise.

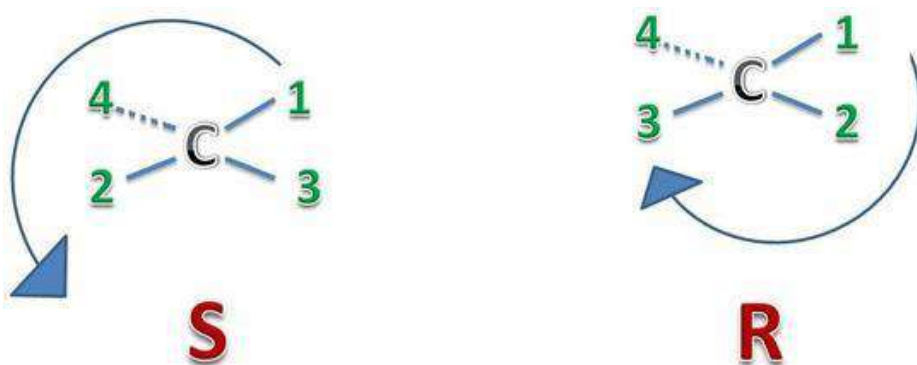

Sequence Rule

- Higher atomic number having atom takes priority over the lower atomic number.

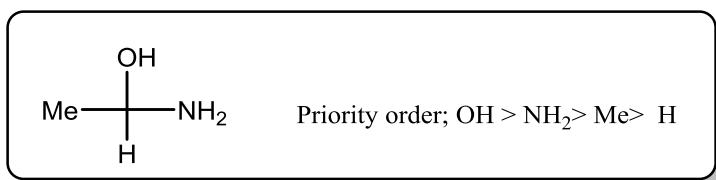

2. In case of isotopes, higher mass number takes priority lower atomic number.

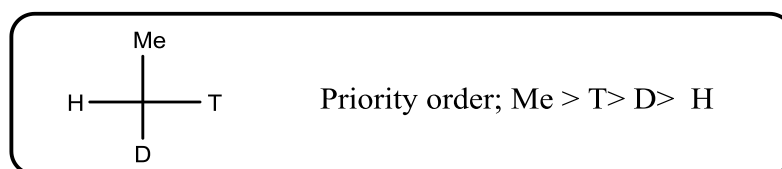

3. When same atoms are attached with a chiral centre, then the next atom of the substituents are considered according to Ist rule (Belt rule).

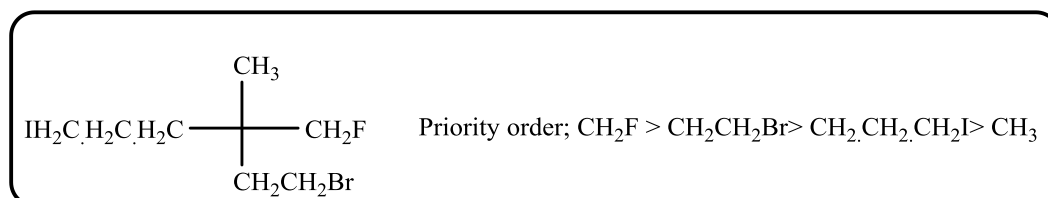

4. Multiple bonds are considered in following ways.

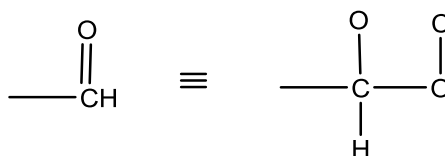

Process for RS Nomenclature

- Draw the Fisher projection formula for given species.
- Apply sequence rule for all the groups or atoms.
- When group follow clockwise order then chosen centre has R-name and if groups follow anticlockwise order then S-name is given to the chosen center.

12.9 D/L Nomenclature (Relative Configuration)

The concept of this nomenclature is based configuration of glyceraldehyde.

Procedure:

- Draw the fisher projection of given species by placing the 'most oxidized group' at the top.
- Place the -H & -OH groups of the highest number on 'Chiral centre' at the horizontal line.
- When -OH group of highest number C-atom is present in Right Hand Side of horizontal line, then D name is given to the compound and 'L' name is given for the vice-versa.
- When 4th priority having group present, on horizontal line then reverse name is given.

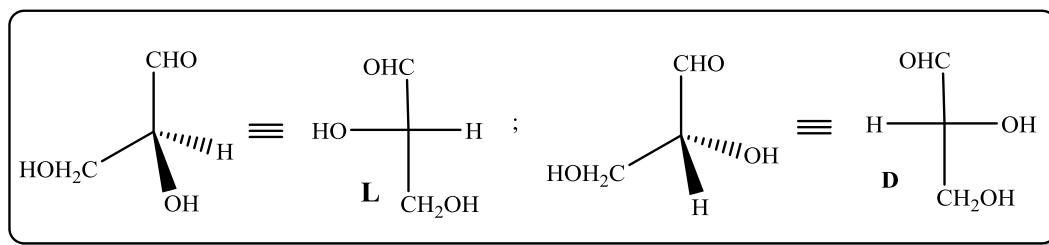

12.10 The E-Z system

The terms "cis" and "trans" are used to designate the geometric isomers of an alkene, which have the identical groups organized differently. E/Z isomerism only happens when there is a difference in the groups that are bound to each carbon atom as $\text{bdC}=\text{Cac}$. In this condition the Cis-Trans nomenclature is not possible. The groups linked to the carbons in the double bond cannot be at a different position because of the constrained rotation about the planar $\text{C}=\text{C}$ double bond. As a result, many isomers are present. Cahn-Ingold-Prelog priority rules are referred to as CIPs. These are the guidelines that establish if a molecule belongs to the *Z* or *E* isomer. When the groups of 'higher priority' on double bonded both carbons are in same side the isomer is *Z* and if both are not same side it means they are opposite to each other the isomer is *E*.

Examples of E/Z nomenclature

The compound 1-bromo-2-chloro-2-fluoro-1-iodoethene having all four different group on $\text{C}=\text{C}$ bond and have the following two arrangements as follows.

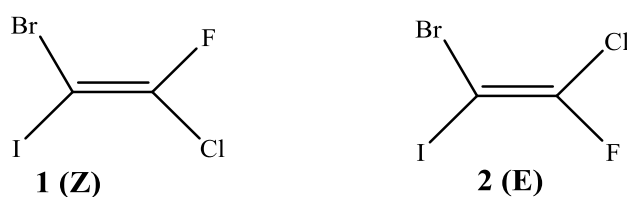

In these structures **1** according to 'sequence rule' the both 'priority groups' Br and F are in same side so this is the *Z* isomer (*zusammen* = together) and in the structure **2** both these groups are in opposite side hence this *E* isomer (*entgegen* = opposite).

Other examples of E/Z nomenclature are as follows.

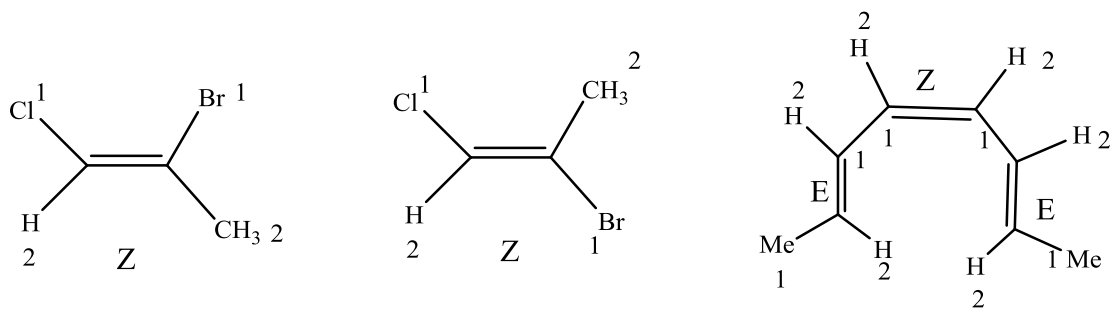

Summary

Chirality is an elementary concept in stereochemistry, referring to the property of molecules. Enantiomers are non-superimposable mirror images of each other, while diastereomers have different configurations at one or more chiral centers. Meso compounds are achiral molecules with chiral centers, exhibiting internal planes of symmetry.

Threo and erythro nomenclature describe diastereomers based on the relative positions of substituents on adjacent stereocenters. D/L and cis-trans nomenclature describe the absolute configuration of stereoisomers. The Cahn-Ingold-Prelog (CIP) rules are used to assign R/S configurations to chiral centers based on the priority of substituents, while E/Z nomenclature.

Keywords

Chirality: The property of a molecule that is non-superimposable mirror image.

Geometrical Isomerism: Stereoisomerism arising from the different spatial arrangement of atoms around a double bond or ring.

Optical Isomerism: Stereoisomerism resulting from the different spatial arrangement and leading to the existence of enantiomers.

MCQs

1. What term is used to describe molecules that are non-superimposable on mirror images?
 - a) Achiral
 - b) Chiral
 - c) Isotopic
 - d) Symmetric

Answer. B

2. Which type of isomerism arises due to different spatial arrangements around a double bond or ring?
- a) Optical isomerism
 - b) Geometrical isomerism
 - c) Conformational isomerism
 - d) Structural isomerism

Answer. B

3. What are enantiomers?
- a) Isomers with the same molecular formula but different connectivity of atoms.
 - b) Isomers that are not superimposable mirror images of each other.
 - c) Isomers with the same spatial arrangement around a double bond or ring.
 - d) Isomers with the same spatial arrangement of atoms but different connectivity.

Answer. B

4. Meso compounds are characterized by:
- a) Having multiple chiral centers.
 - b) Being optically inactive despite containing chiral centers.
 - c) Being chiral and exhibiting optical activity.
 - d) Having an odd number of carbon atoms.

Answer. B

5. Which of the following nomenclatures is used to describe the relative positions of substituents around a double bond?
- a) D/L nomenclature
 - b) E/Z nomenclature
 - c) R/S nomenclature
 - d) Threo/erythro nomenclature

Answer. B

Self-assessment

1. Define chirality and provide examples of chiral and achiral molecules.
2. Describe the difference between geometrical and optical isomerism, providing examples of each.
3. What are enantiomers and diastereomers? Provide examples to illustrate the difference between these two types of stereoisomers.
4. Explain what makes a compound a meso compound and provide an example.
5. Define threo and erythro nomenclature and explain their significance in describing diastereomers.
6. Discuss the significance of the D/L notation in stereochemistry.
7. Explain the principles behind cis-trans nomenclature and provide examples.

UNIT - 13

Alkanes

Objectives

- Understand the preparation methods of alkanes.
- Learn about various synthetic routes for alkanes
- Study the reactions of alkanes, focusing on free radical substitution mechanisms, particularly halogenation.

13.1 Hydrocarbon:

Hydrocarbons are organic compounds formed by the combination of hydrogen and carbon. Many type of fuels like Coal gas, LPG ((Liquid Petroleum Gas), and CNG (Compressed Natural Gas) are formed by mixing of various of hydrocarbons.

Alkanes: Simplest member of Hydrocarbons is Alkanes with only single covalent bond in between Hydrogen and carbon atoms and Carbon –carbon atom. Common formula of Alkanes is C_nH_{2n+2} .

Alkanes also known as Paraffins due to its less reactivity towards reagents.

13.2 Nomenclature: In the nomenclature of alkanes suffix “ane” is used and prefix is denoted according to number of carbon atom present in parent structure. IUPAC nomenclature for some basic alkanes are as follows:

S. No	Structure	Number of carbon atoms	IUPAC name
1	CH ₄	1	Methane
2	CH ₃ CH ₃	2	Ethane
3	CH ₃ CH ₂ CH ₃	3	Propane
4	CH ₃ (CH ₂) ₂ CH ₃	4	Butane
5	CH ₃ (CH ₂) ₃ CH ₃	5	Pentane
6	CH ₃ (CH ₂) ₄ CH ₃	6	Hexane
7	CH ₃ (CH ₂) ₅ CH ₃	7	Heptanes
8	CH ₃ (CH ₂) ₆ CH ₃	8	Octane
9	CH ₃ (CH ₂) ₇ CH ₃	9	Nonane
10	CH ₃ (CH ₂) ₈ CH ₃	10	Dodecane

Isomerism of Alkanes: Compound have same molecular formula and different structure is called isomers. In alkanes structural isomerism is present.

Examples:

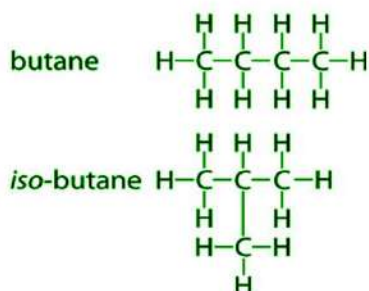

Isomers of Butane

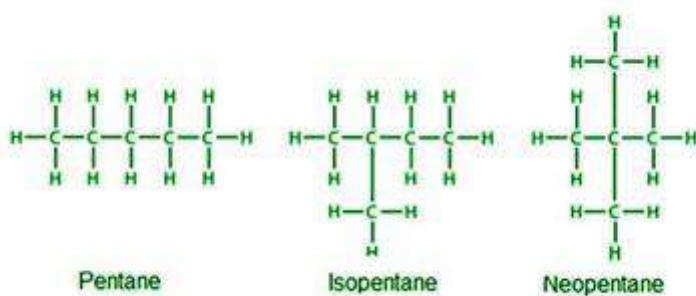

Isomers of Pentane

Natural sources of alkanes:

- Petroleum and Natural gases sources of aliphatic hydrocarbons.
- Constituents of natural gas are methane, ethane, propane and butane.

13.3 Methods of Formation:

1. **Kolbe's electrolysis method:** On the electrolysis of aqueous solution of carboxylic acid salt of sodium and potassium alkanes are formed. Electrochemical oxidative

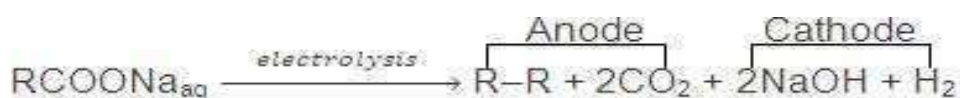

decarboxylation of carboxylic acid carried out by free radical mechanism and synthesis of symmetrical dimers take place.

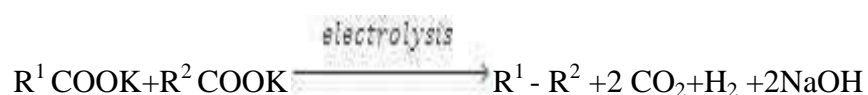

(R¹ - R¹ and R² -R² can form).

2. **Corey-House synthesis:** Alkyl chloride/ chloroethane in presence of ether, reacts to lithium to form lithium alkyl then this lithium alkyl reacts with CuI form lithium dialkylcuprate. Atlast lithium dialkylcuprate form alkane when reacts with alkyl chloride.

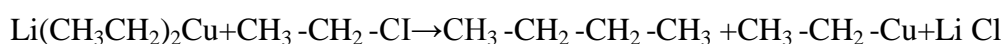
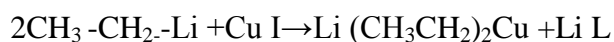
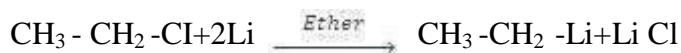

3. **Grignard reaction:** Alkyl halides (Alkyl bromides and Alkyl iodides) react with magnesium metal in the presence of dry diethyl ether and form Alkyl magnesium halide. Alkyl magnesium halide reacts with water form alkanes.

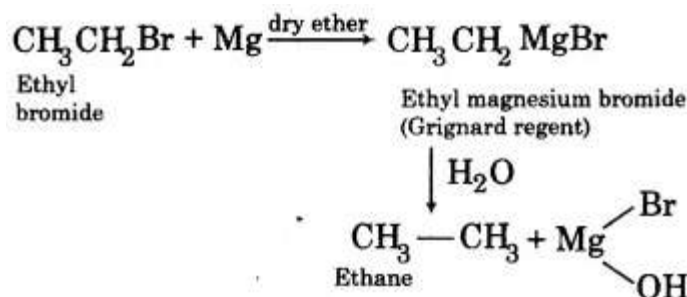

4. **Hydrogenation of alkenes:** Also named Sabatier and Senderen's method. Alkanes are formed by the catalytical Hydrogenation of alkenes and Alkynes. Ni is used as catalyst in the reaction.

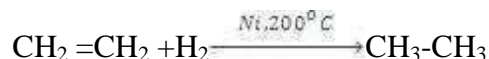

5. **Wurtz reaction:** When alkyl halide solution heated with sodium in ether form alkane.



By the wurtz reaction symmetrical alkanes with even carbon number can be synthesized. If used two different alkanes all the possible alkanes are formed by Wurtz reaction.



6. **Reduction of Carbonyl compounds:** Reduction of carbonyl compounds are carried out in the presence of amalgamated zinc and conc. HCl to form alkanes. This process is known as Clemmensen reduction.

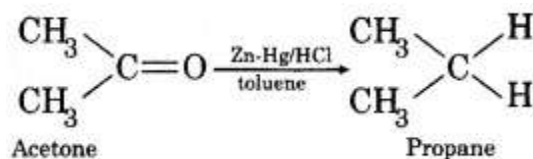

7. **Wolf Kishner reaction:** When carbonyl compounds are reduced to alkanes when reacted with hydrazine in presence of sodium and ethanol.

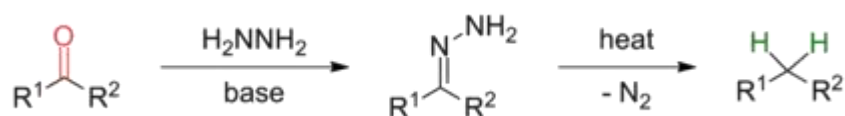

13.4 Physical Properties of Alkanes:

1. **Physical state:** Initial four members from C₁-C₄ are gases. From C₅-C₁₃ are liquids and higher members are colourless waxy solids. Alkanes are colorless, tasteless, and nearly odorless in pure state.
2. **Boiling point:** In straight chain alkanes boiling point increases with increase in molecular mass because of when molecular size and surface area of the molecule increases then the van der Waals forces of attraction arises and boiling point increases.
3. **Melting point:** With increase of molecular weight melting point of alkanes increases. Alkanes with even number alkanes have higher melting point than odd-numbered alkanes.
4. **Solubility:** Because of less electronegativity difference between carbon and hydrogen alkanes are show non-polar characteristics. Therefore Alkanes are insoluble in polar solvents like water, ethinol and soluble in non-polar solvents like petrol, ether, benzene, carbon tetrachloride etc.
5. **Density:** Density is inversely proportional to the volume so density of alkanes increases with increasing the no. of carbon atoms. Alkanes are less dense in compare to water so they float on water.

13.5 Chemical Properties of Alkanes:

1. **Combustion:** When alkanes ignited in presence of sufficient oxygen undergoes combustion and form carbon dioxide and water.

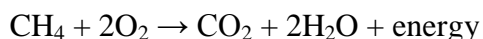

2. **Halogenation:** The reaction in which replacement of one or more hydrogen atom is carried out by same number of halogen atom in alkanes are called halogenations.

Reactivity order of halogen towards halogenations is $\text{F}_2 > \text{Cl}_2 > \text{Br}_2 > \text{I}_2$

- a. **Chlorination:** Chlorination occurs in alkanes when they are reacted with chlorine in presence of sunlight or UV light.

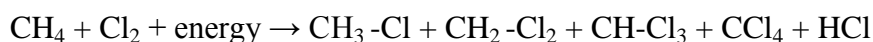

Mechanism: Mechanism is divided in three steps:

- i. **Initiation :** Chlorine free radical are formed by Homolytic bond cleavage
- ii. **Propagation:** This is further divided in two steps.
 - a. **Step:** Chlorine free radical react with hydrogen on methane and HCl formed in first step.
 - b. **Step:** chlorine atom reacts with methyl radical and form chloromethane and one free chlorine radical. This step is exothermic.
- iii. **Termination:** In this step all free radicals mix with each other and form different type of product like CH_3Cl , Cl_2 and CH_3CH_3 .

Initiation



Propagation



Termination

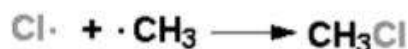

3. **Nitration:** At high temperature 400-500 °C in presence of HNO_3 and N_2O_4 (nitrating

agent) C-H and C-C bonds can be broken.

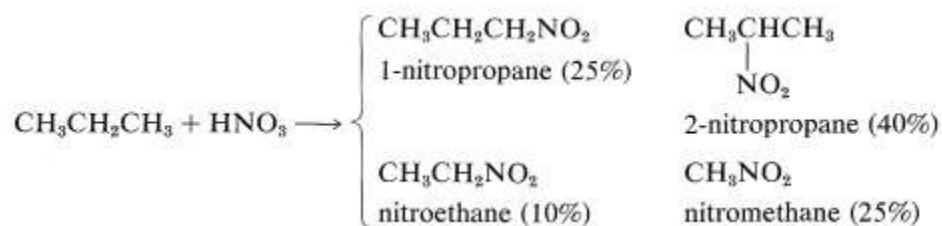

4. **Sulphonation:** Alkanes with 6 and more carbon atom sulphnated by sulphuric acid but lower alkane get sulphonated if they have tertiary hydrogen atom

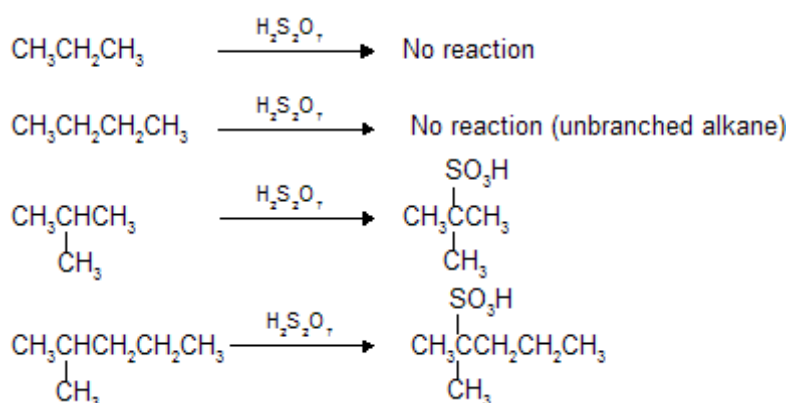

5. **Catalytic oxidation of Alkanes:** Catalytical oxidation or Controlled oxidation form alcohols or aldehydes or carboxylic acids based on reaction condition.

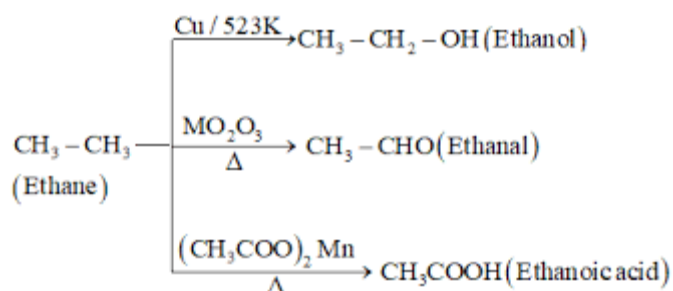

Summary

Alkanes are saturated hydrocarbons containing only carbon-carbon single bonds. They can be prepared through various methods, including catalytic hydrogenation, Wurtz reaction (coupling of alkyl halides), Kolbe's synthesis (decarboxylation of carboxylic acids), and from Grignard reagents (by reacting alkyl halides with magnesium). The reactions of alkanes primarily involve free radical substitution mechanisms with halogenations.

Keywords

Catalytic Hydrogenation: A chemical reaction in which hydrogen gas is added

Grignard Reagent: An organometallic compound made up of alkyl halide with magnesium metal.

MCQs

1. Which method is commonly used for the preparation of alkanes up to five carbons through the reaction of alkyl halides with magnesium?
 - a) Catalytic hydrogenation
 - b) Wurtz reaction
 - c) Kolbe's synthesis
 - d) Dehydration

Answer: B

2. Which reaction is a common method for the preparation of alkanes through the decarboxylation of carboxylic acids?
 - a) Catalytic hydrogenation
 - b) Wurtz reaction
 - c) Kolbe's synthesis
 - d) Dehydrohalogenation

Answer: C

3. What type of reaction is involved in the conversion of alkyl halides to alkanes using magnesium metal?
 - a) Nucleophilic substitution
 - b) Electrophilic addition
 - c) Electrophilic substitution
 - d) Free radical substitution

Answer: D

4. Which method is commonly used for the preparation of alkanes up to five carbons through the reduction of alkyl halides?
 - a) Catalytic hydrogenation
 - b) Wurtz reaction

- c) Kolbe's synthesis
- d) Dehydrohalogenation

Answer: B

5. In the reaction between alkyl halides and magnesium in the Wurtz reaction, what is the role of magnesium?
- a) It acts as a reducing agent.
 - b) It acts as a catalyst.
 - c) It forms a Grignard reagent.
 - d) It forms a complex with the alkyl halide.

Answer: C

Self-assessment

1. Describe the mechanism of the Wurtz reaction for the preparation of alkanes.
2. How does the formation of alkyl radicals occur in the initiation step of free radical halogenation of alkanes?
3. Explain Saytzeff's rule and its application in dehydrohalogenation reactions

UNIT - 14

Alkenes and Alkynes

Objectives

- Understand the preparation methods of alkenes.
- Explore the elimination reactions involved in the preparation of alkenes.
- Differentiate between cis and trans alkenes and understand their synthesis.
- Examine the reactions of alkenes

14.1 Introduction: Alkenes are unsaturated organic compounds with at least one carbon double bond. Common formula of alkenes is C_nH_{2n} . Alkenes are also known as Olefins because first member of alkenes series form oily compound with chlorine.

14.2 Nomenclature:

1. Common system: Common name of alkenes given by replacing the “ane” by ‘ylene” that is Alkane named as Alkylene.
2. IUPAC nomenclature: Branched and substituted alkenes are named similarly to alkanes by using suffix “ene”. Example

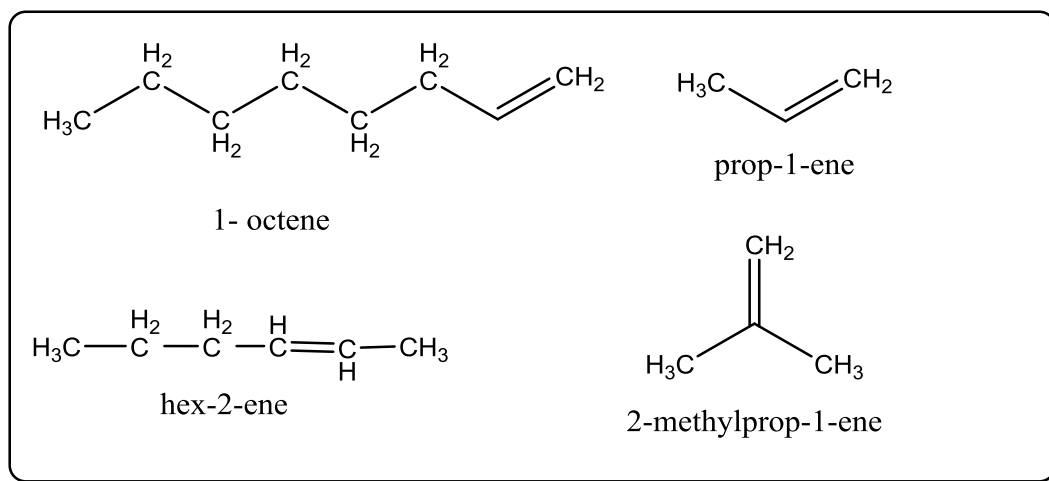

14.3 Isomerism: Structural and Geometrical Isomerism present in Alkenes.

Example of Structural Isomers:

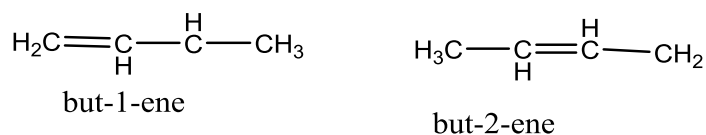

Example of Geometrical Isomerism:

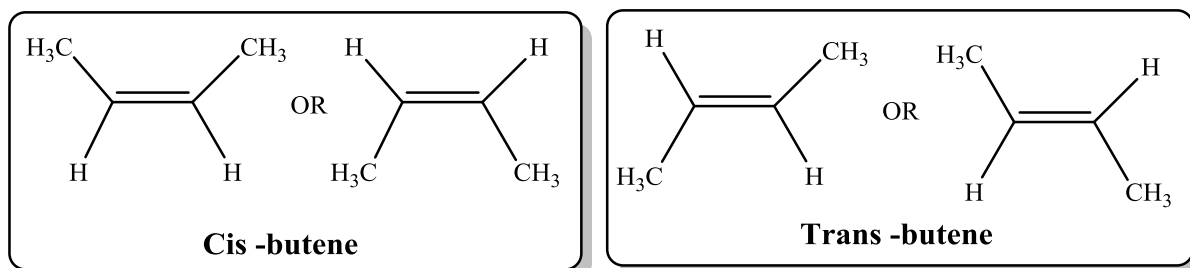

14.4 Preparation Methods of Alkenes:

- 1. Dehydration of Alcohols:** Alcohols heated with conc. H_2SO_4 at $160 - 170^\circ\text{C}$ to form alkenes and loss of water molecule take place. In this reaction H_2SO_4 and H_3PO_4 act as Dehydrating agents.

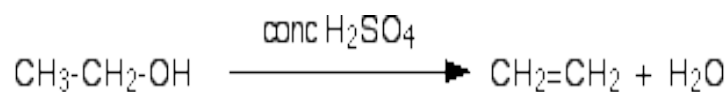

- The order of dehydration is: Tertiary alcohol > Secondary alcohol > Primary alcohol.
- 3° alcohols undergoes dehydration under mild condition at 50°C and in presence of 5% sulphuric acid.

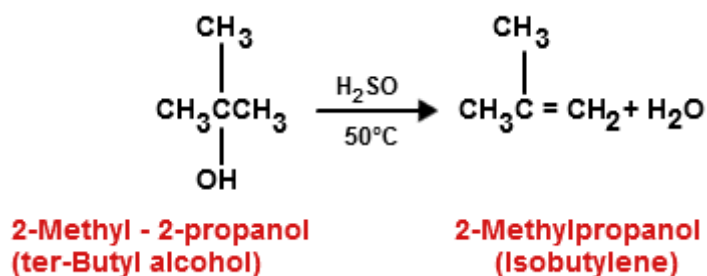

- Secondary and tertiary alcohols undergo dehydration fast than primary alcohol because they form stable secondary and tertiary carbocations.

Mechanism of dehydration of Alcohols:

Rearrangements in Dehydration of Primary Alcohols

Step 1. Protonation of the hydroxyl group

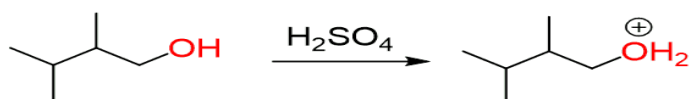

Step 2. 1,2 shift of β -hydrogen forming a carbocation

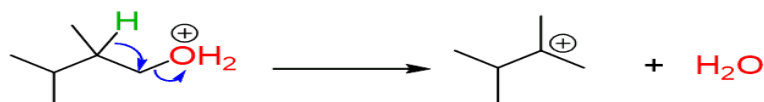

Step 3. Removing β -hydrogen to form a π bond

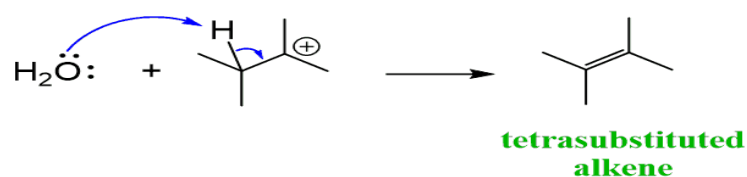

- When the vapour of an alcohol passing on the heated alumina (Al_2O_3) at 623 K undergoes dehydration.

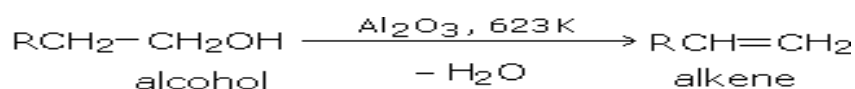

For example,

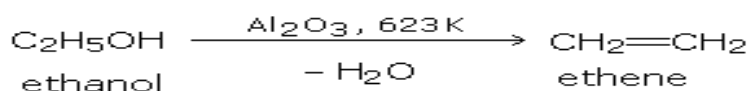

2. Dehydrohalogenation of Alkyl halides:

Alkyl halides heated with alcoholic KOH to form alkenes by eliminating HX from the nearby carbon atoms. This reaction is also known as “ β -elimination reaction”.

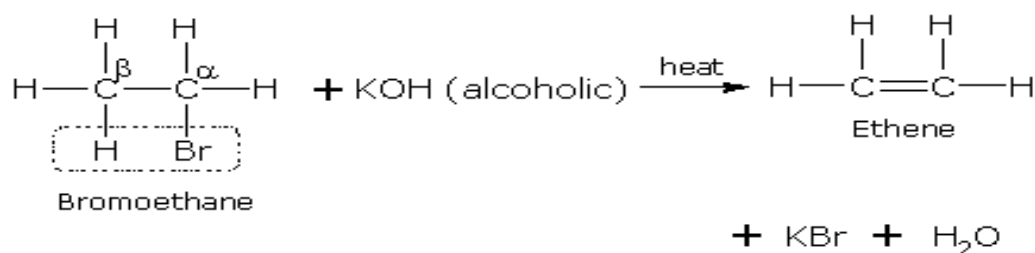

Dehydration reaction gives the mixture of isomeric alkenes. It is not possible to predict which isomer predominates on the basis of molecular structure. For this

Saytzeff's rule is used. According to this rule, the main product of the dehydration of an alkene, in which double-bonded carbon atoms are attached with a higher number of alkyl groups.

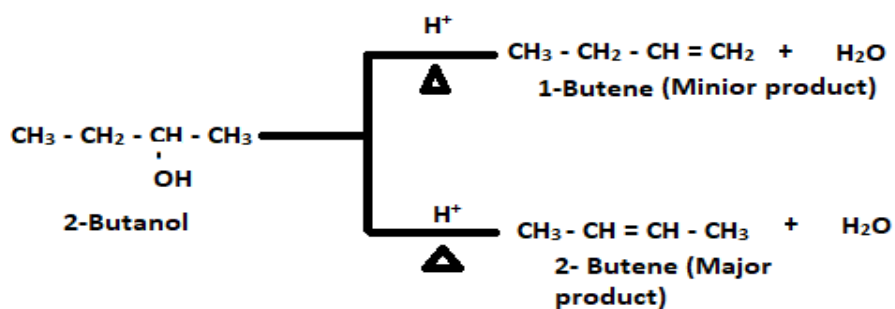

Mechanism of dehydrohalogenation: There are two types of elimination reactions

a. E2 reaction: Bimolecular elimination reaction

- Since the rate of reaction depends on the concentration of both reactants, hence it is known as a second-order reaction.
- The reaction is carried out in one step.
- Towards E2 reaction, the reactivity order of alkyl halide is $3^\circ > 2^\circ > 1^\circ > \text{ethyl halide}$.
- The reaction rate of E2 is faster as the reactant with a better leaving group is used because the leaving group is easily removed in the rate-determining step. $\text{R-I} > \text{R-Br} > \text{R-Cl}$

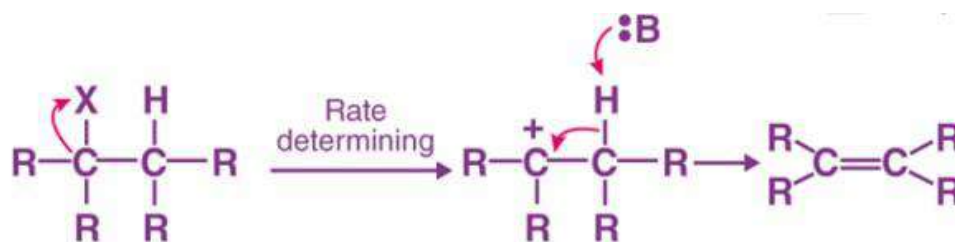

b. E1 elimination reaction:

- Also known as unimolecular elimination reaction.
- Only the concentration of the alkyl halide affects the reaction.
- The reaction is carried out in two steps.
- Towards E1 reaction, the reactivity order of alkyl halide is $\text{ethyl halide} > 1^\circ > 2^\circ > 3^\circ$.

Mechanism:-

Step 1:

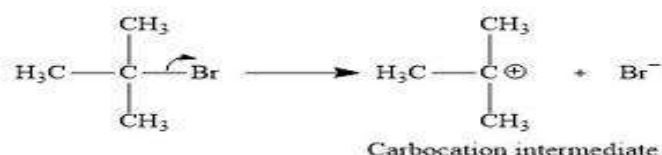

Step 2:

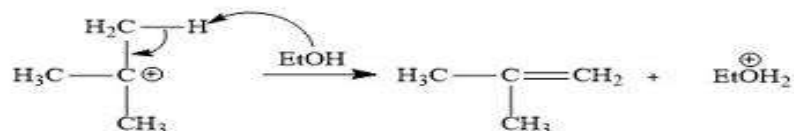

14.5 Physical Properties of Alkenes:

- 1) Alkenes are colorless and odorless compounds with have characteristic smell.
- 2) Initial Member of alkenes from $\text{C}_1 - \text{C}_4$ are gases, alkenes with $\text{C}_5 - \text{C}_{14}$ are liquids and higher alkenes are solids.
- 3) Alkenes are nonpolar or weak polar compounds due to this they are water in soluble and soluble in polar organic solvents like alcohol, ether etc. Alkenes are lighter than water because of less density in compare to water.
- 4) Alkenes has less value of boiling point and melting point than alkane of similar number of carbon atoms.
- 5) With increase of number of carbon atom increase its boiling point and melting point also increase.
- 6) Boiling point and melting point of straight chain alkenes is greater than branched chain alkenes due to surface area.
- 7) Boiling point and melting point of trans isomer is higher than cis isomer.
- 8) Alkenes have greater Dipole moments than alkane due to polarity of double bonds,

14.6 Chemical reaction of Alkenes:

1. **Hydrogenation** – In presence of metal catalyst Pt/Pd/Ni alkenes react with Hydrogen and form alkanes as product.

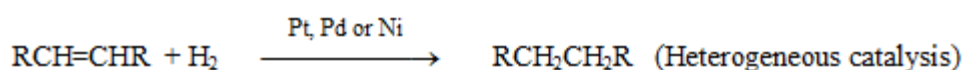

Reactivity order of Alkenes for Hydrogenation reaction is :

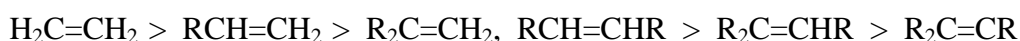

2. **Electrophilic addition reaction** – Due to the presence of carbon carbon double bond which contain one σ -bond and one π bond in which π bond is weak so it break to form two new σ -bond for electrophilic addition reaction.

- Formation of carbonium ion
- Formation of addition product from carbonium ion

a. **Addition of Hydrogen Halides**

Haloalkanes are formed by addition reaction of alkenes and Hydrogen halides to double bond of alkenes.

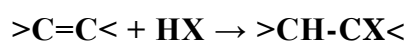

Mechanism: Electrophilic addition reaction of hydrogen halide at alkenes carried out in two steps: 1st step is slow step and rate determining step and 2nd step is fast step.

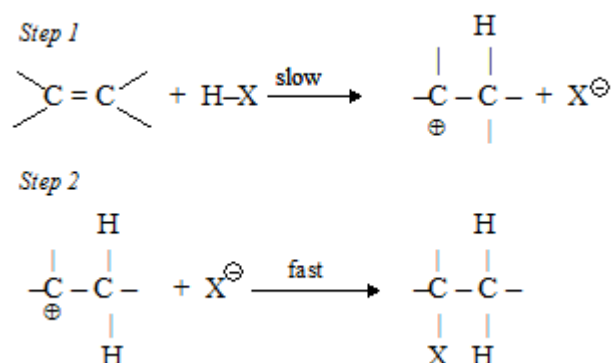

When HBr react with some alkenes formation of alkyl mixture and an isomer carried out by rearrangement.

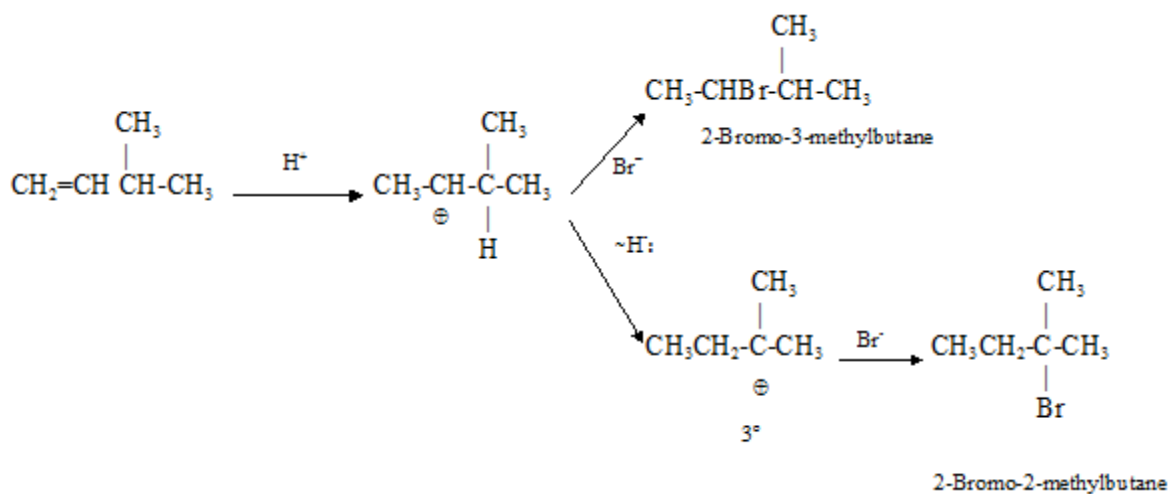

2-iodobutane form as a product when HI reacts with 1-butene which have a stereocenter.

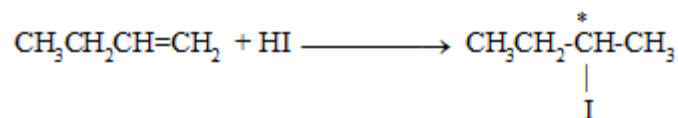

Markovnikov's Rule: Rule state that negative part attacking species attached to the carbon with less number of hydrogen atoms.

According to this rule in addition of HX to alkene, H-atom attack to double bonded carbon atom which have more hydrogen atom and halide ion goes to doubly bonded carbon atom which have less number of carbon atom.

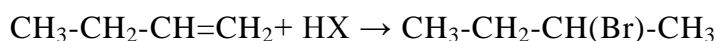

Mechanism of Markonikov's:

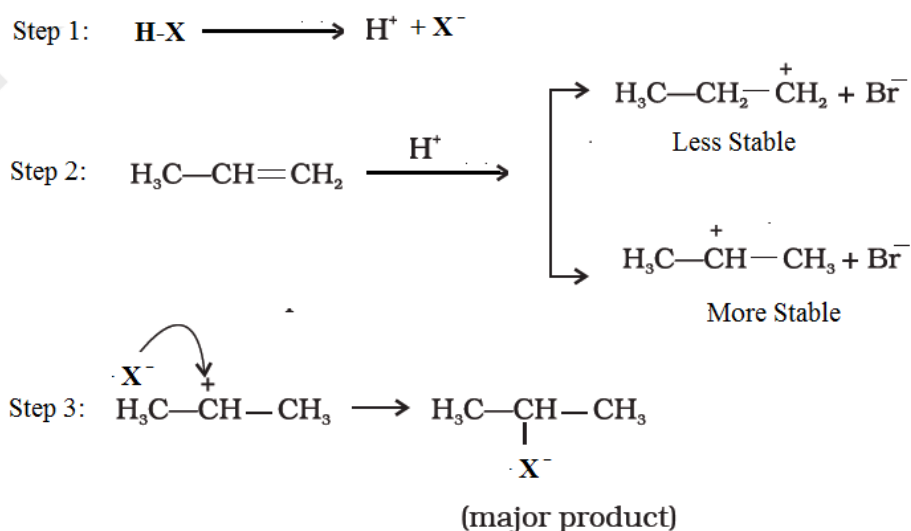

Peroxide effect or Anti-Markonikov's Rule

When the addition reaction of HX to alkenes in presence of peroxides, reverse markovnikov's rule applicable on HBr and not on HCl and HI .

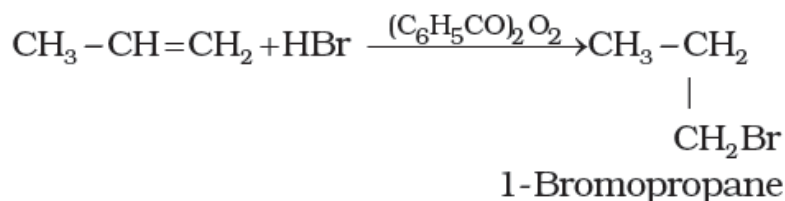

Mechanism of Aniti-Markonikov's Addition

Peroxide effect is carried out with free radical chain mechanism.

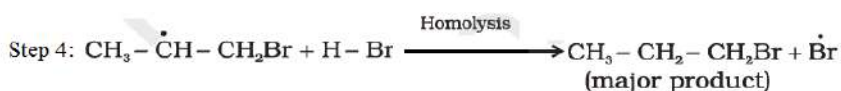
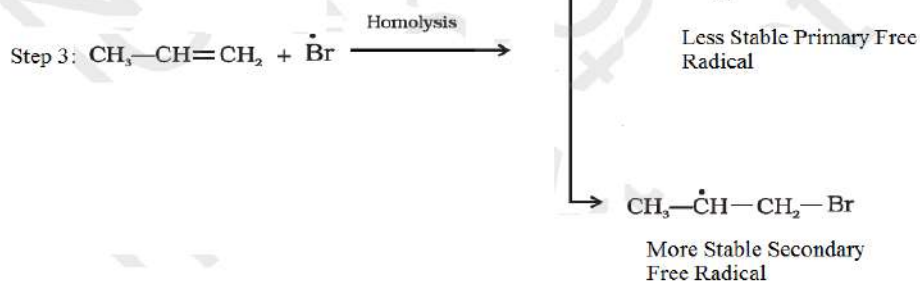
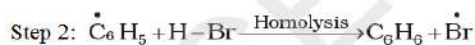

3. Oxidation of Alkenes

- a. **Combustion:** In combustion of alkene heat is released in process with high calorific values.

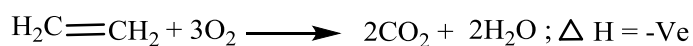

- b. **Baeyers' Oxidation or hydroxylation: It is a basic test for unsaturation.**

When alkenes are react with alkaline KMnO_4 / Baeyers reagent, remove pink colour of KMnO_4 and formed diols e.g. glycols as product.

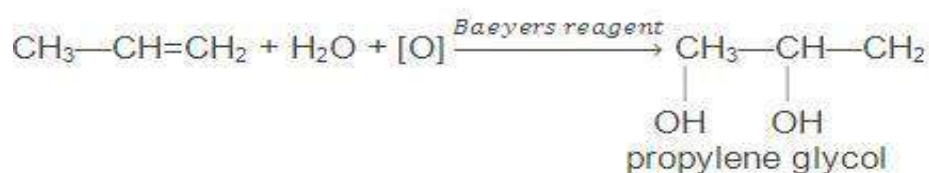
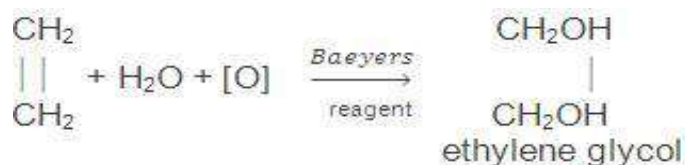

- c. **Oxidation by alk. KMnO_4 :** Two acid salts form by the oxidation of alkenes by hot alkaline KMnO_4 .

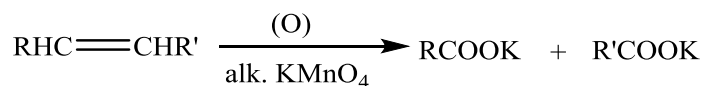

d. Oxidation via acidic $\text{K}_2\text{Cr}_2\text{O}_7$ or KMnO_4 :

Alkenes give carboxylic acid on oxidation in the presence of acidic KMnO_4 or $\text{K}_2\text{Cr}_2\text{O}_7$.

CO_2 & H_2O is formed by the complete oxidation of HCOOH .

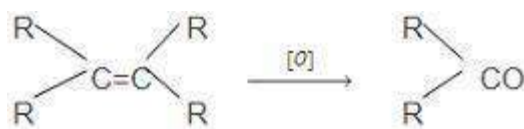

4. **Ozonolysis of Alkenes-** Alkenes react with ozone to form unstable compound ozonides

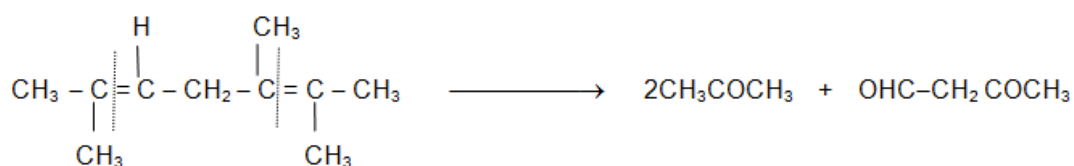
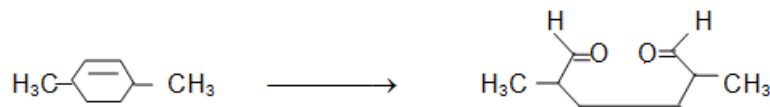
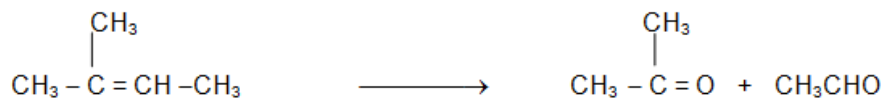
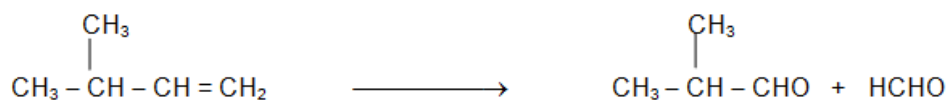
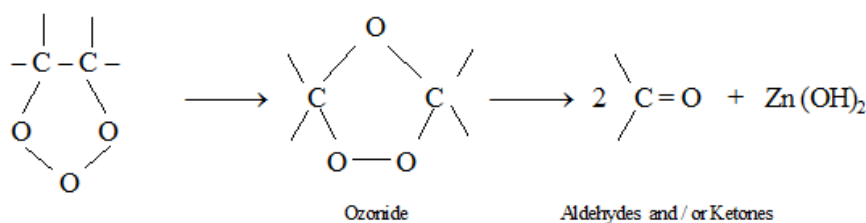

5. Isomerization of Alkenes

In the presence of catalyst like AlCl_3 or $\text{Al}_2(\text{SO}_4)_3$, alkenes are heated at high temperature 500 to 700°C and undergo isomerization.

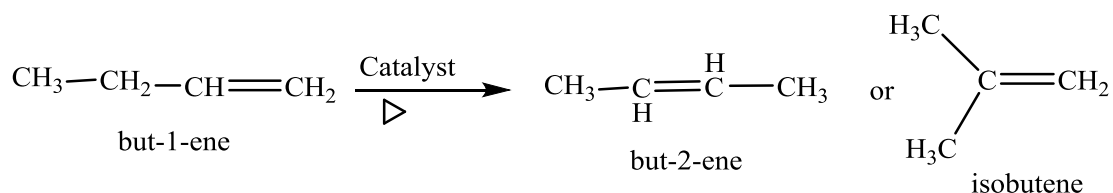

6. Allylic Substitution

At high temperature alkene except Ethane alkyl group undergoes free radical substitution in presence of Cl_2 or Br_2 .

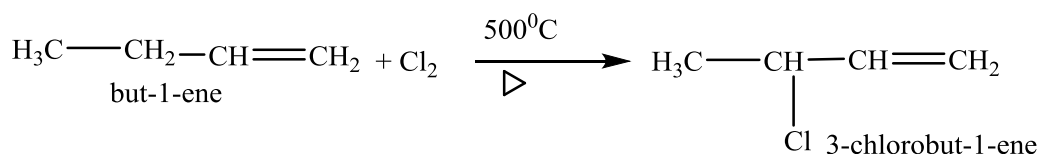
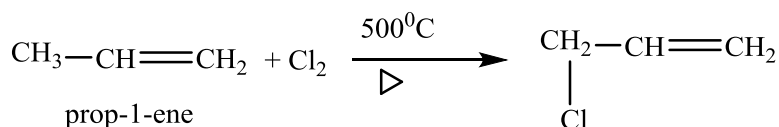

7. Wohl-Ziegler Bromination. Bromination of alkynes takes place in presence of NBS.

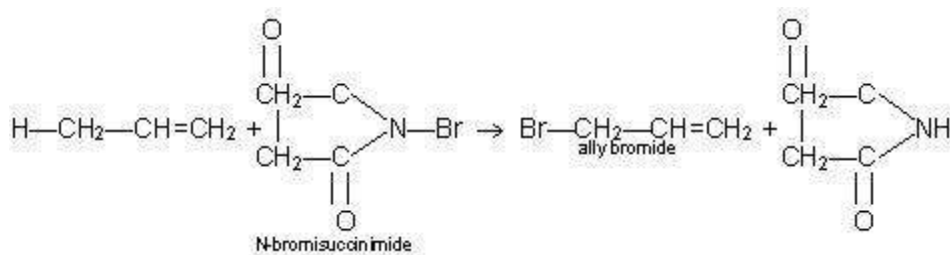

8. Oxy-Mercuration-Demercuration

In presence of water alkenes react with mercuric acetate to form hydroxymercurial compounds which reduced to alcohols.

i. Step: Oxymercuration: -OH and HgOAc involve in addition on the C-C double bond.

ii. Step: Demercuration: In this step H replace the HgOAc .

The addition product in Oxymercuration-demercuration follows Markovnikov rule.

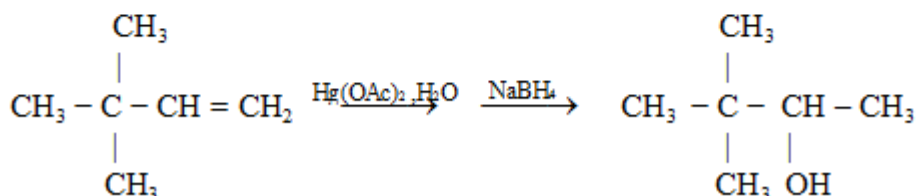
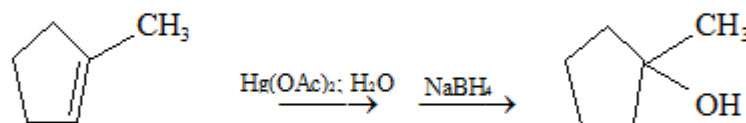
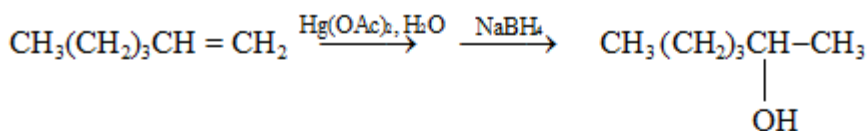

14.7 Alkyne

Alkynes are unsaturated hydrocarbons having $\text{C}\equiv\text{C}$ bond. Common formula of alkynes is $\text{C}_n\text{H}_{2n-2}$.

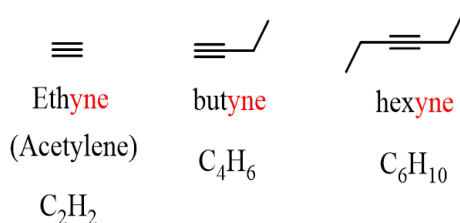

14.7.1 Nomenclature

IUPAC System: IUPAC nomenclature of alkynes are similar to alkanes only suffix “ane” is replaced by suffix “yne” in the corresponding alkanes. Example:

Structure	IUPAC name	Common name
$\text{HC}\equiv\text{CH}$ $\text{CH}_3-\text{C}\equiv\text{CH}$	Ethyne Propyne	Acetylene Allylene or Methylacetylene
$\text{CH}_3-\text{CH}_2-\text{C}\equiv\text{CH}$ $\text{CH}_3-\text{C}\equiv\text{C}-\text{CH}_3$	But-1-yne But-2-yne	Ethylacetylene Crotonylene or Dimethyl acetylene

14.7.2 Isomerism: Structural isomerism are shown by the alkynes.

1. Chain Isomer – Different chain length is present in different compounds with similar molecular formula.

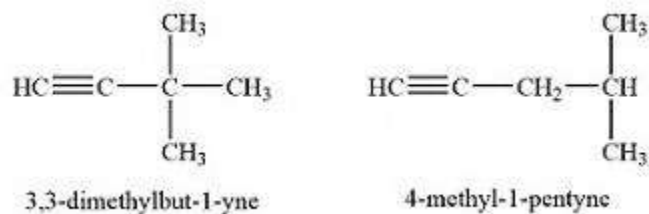

2. Position isomer: Position of triple bond is different in different compounds but have same molecular formula.



14.7.3 Preparation methods of Alkynes

1. **Dehydrohalogenation of dihaloalkane-** Dihaloalkane in presence of alcoholic KOH react with NaNH_2 form alkynes

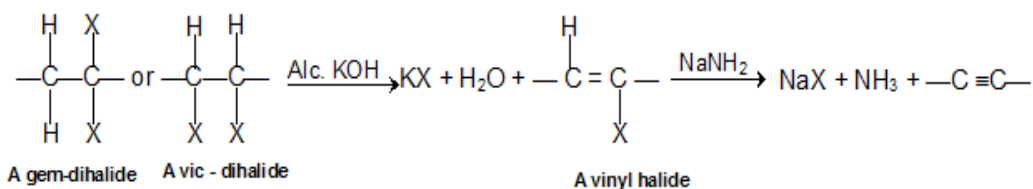

2. **From Vinylhalide** - Vinylhalides react with NaNH_2 form alkynes.

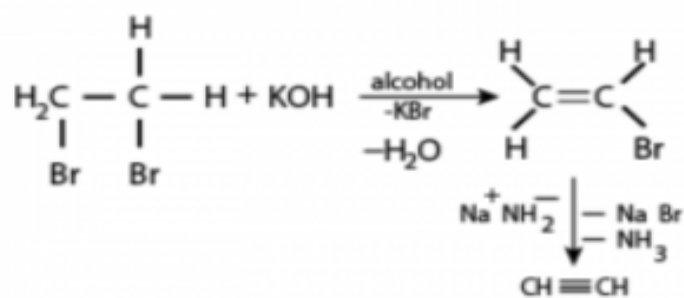

3. **From tetrahaloalkane-** Tetrahaloalkane in presence of alcohol react with Zn dust from alkynes

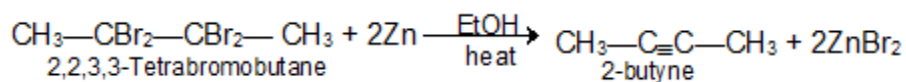

4. **From Calcium Carbide-** By hydrolysis of CaC_2 we can form alkyne at industrial level

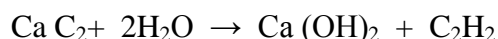

14.7.4 Physical Properties

1. At room temperature initial members of alkynes from C_2 - C_4 alkynes are gas, from C_5 - C_{11} are liquids and greater are solids.
2. Alkynes are partially water soluble and completely soluble in organic solvents like benzene.
3. The 'Melting and Boiling Points' of alkynes is higher than corresponding alkenes. As the carbon number increases boiling point increases.

14.7.5 Chemical properties of alkynes

1. **Hydrogenation-** Alkynes undergoes catalytic hydrogenation in presence of hydrogen and catalyst Pt/Pd/Ni at 200°C temperature.

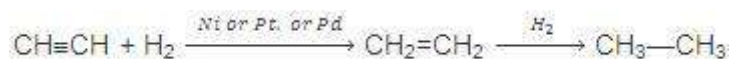

2. **Electrophilic addition reaction** -Due to the unsaturation alkynes undergoes Electrophilic addition.

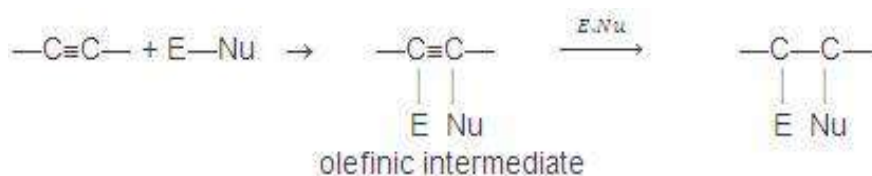

Alkynes give addition reaction with following reagents:

- a. **Addition of halogen** – Alkynes form 2 mole of halogen in the presence of Lewis acid form tetra haloalkane.

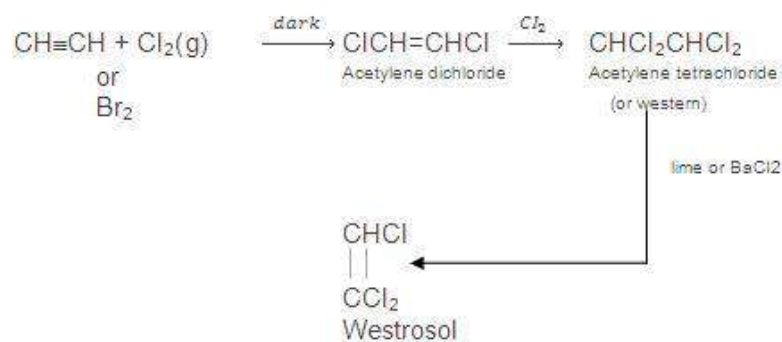

- b. **Hydrohalogenation:** Addition of HX on alkynes done according to 'Markownikoff's' rule.

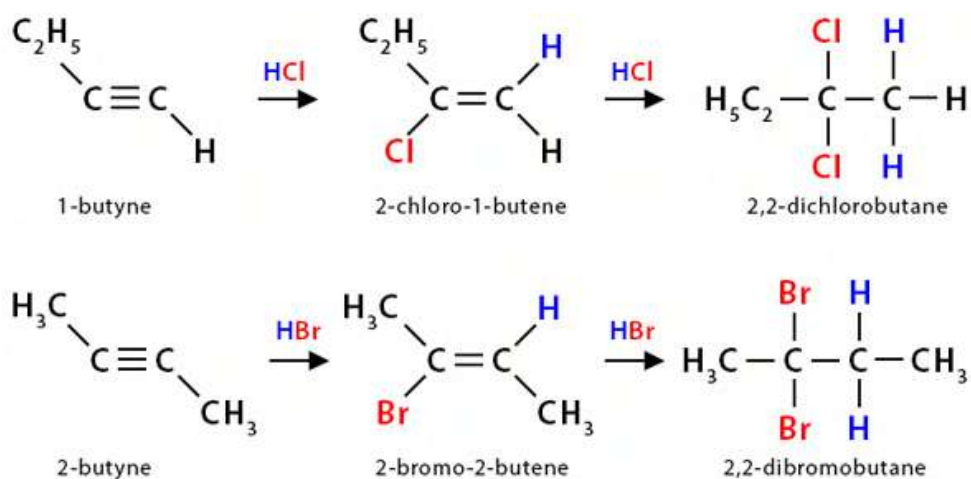

Order of 'Reactivity' hydrogen halides = H-I > H-Br > H-Cl

- c. **Addition of sulphuric acid** – In presence of acid catalyst alkynes react with sulphuric acid form carbonyl compounds.

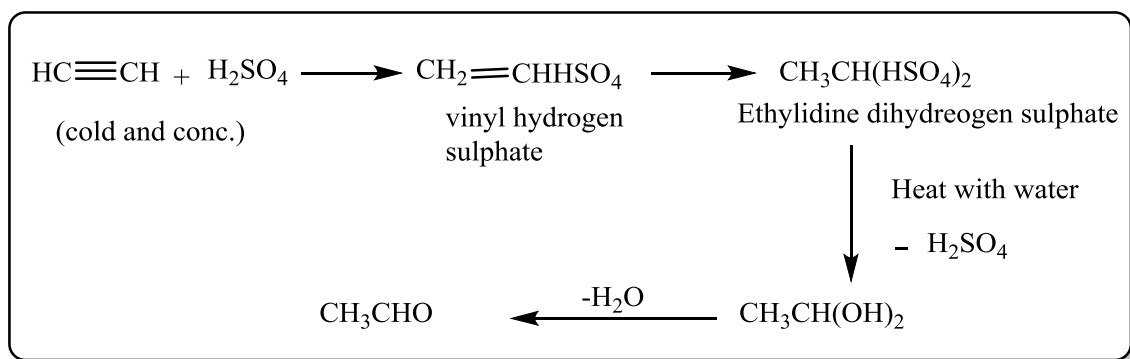

- d. **Addition of H₂O (Hydration)** : In the presence of Hg⁺ as catalyst When alkynes is passed into dilute sulphuric acid at 60°C, react with one molecule of water to form acetaldehyde.

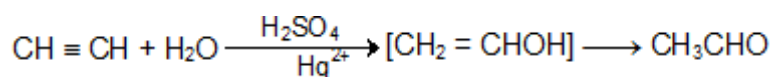

- e. **Oxidation Reaction** – Alkynes in presence of alkaline KMnO₄ on oxidation form dicarbonyl compound which on further oxidation form carboxylic acid

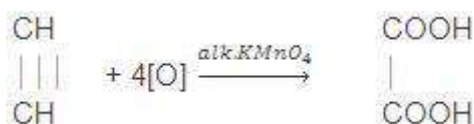

- f. **Ozonolysis**: When alkynes reacts with ozone form carboxylic acid as product.

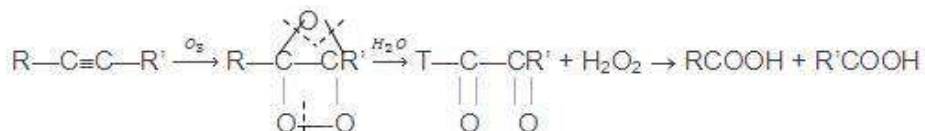
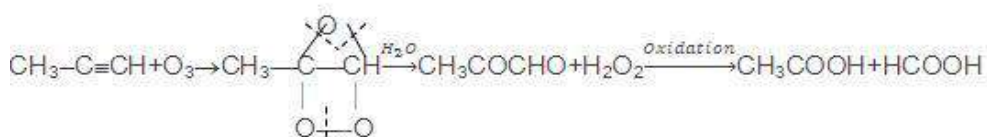
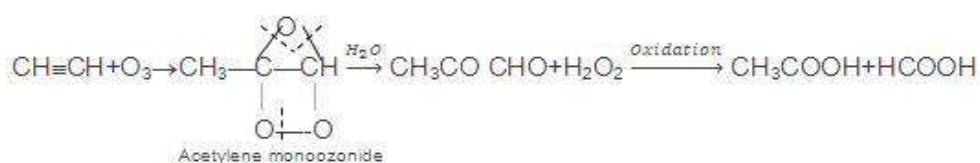

- g. Acidic nature of alkynes:** Alkynes are more acidic than alkene because of in alkynes C atom is SP hybridization which contain 50% s character and 50% p character so hybrid orbital which has more s character has electrons are more near to the nucleus and are attract towards it . So alkynes give proton more easily than alkene.

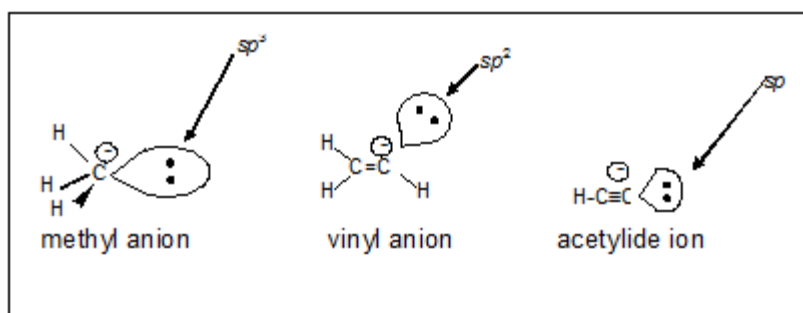

- h. Substitution reactions** – Due to the high electronegativity of triple bond alkyne are easily react with electrophile and give substitution reactions.

i. Alkynides Formation :

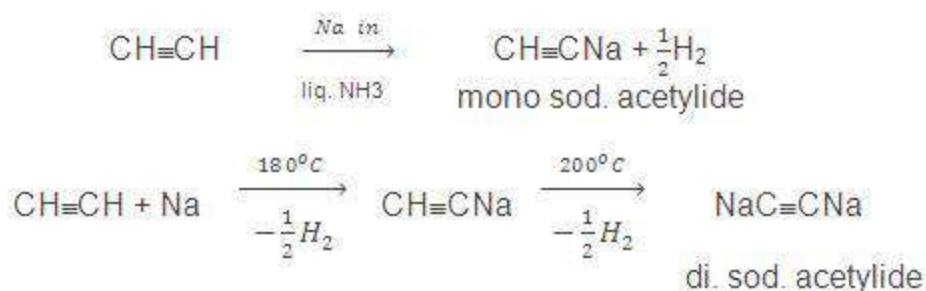

j. Copper alkynides formation: Alkynes form red ppt of cuprous alkynide, when passing from ammoniacal cuprous chlorides solution.

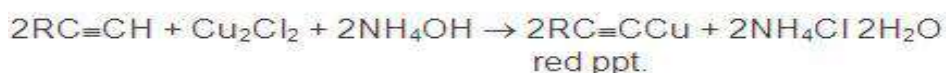
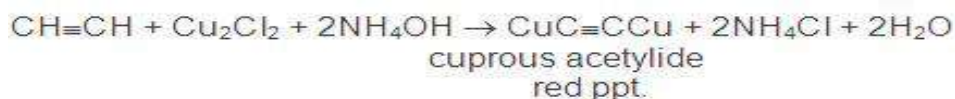

k. Formation of silver alkynides: When alkynes react with ammoniacal silver nitrate solution gives silver acetylide as white precipitate.

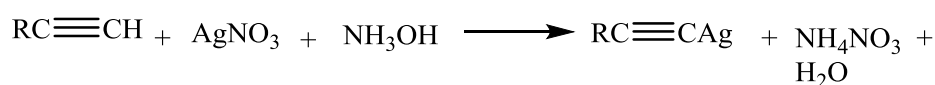
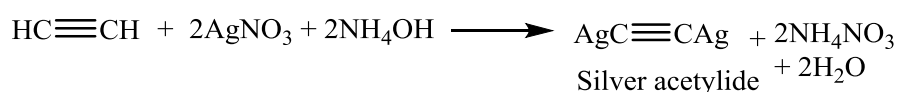

l. Polymerisation reaction: Different types of polymeric compounds are formed by 'polymerization' of alkynes.

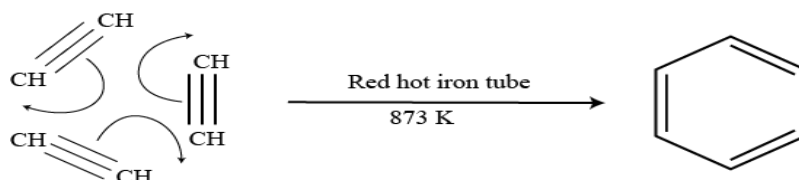

m. Isomerization of Alkynes:

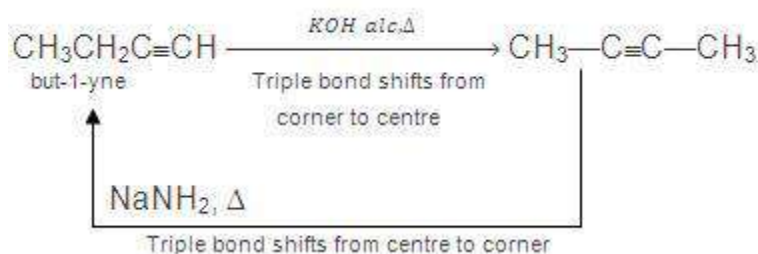

Uses of Alkynes

1. Acetylene has industrial applications.
2. Used for artificial ripening of fruits.
3. Prepare Lewisite which is poisonous gas.
4. Used in Naracylene as general anesthetic.

Summary

Unsaturated hydrocarbons containing one carbon-carbon double bond are known as Alkenes. They can be prepared through elimination reactions. The synthesis of cis and trans alkenes involves partial catalytic hydrogenation and Birch reduction, respectively.

Alkenes undergo various addition reactions, including cis and trans addition with permanganate and bromine, Markovnikov's and anti-Markovnikov's addition of HX, hydration, ozonolysis, oxymercuration-demercuration, and hydroboration-oxidation, each leading to different products with distinct stereochemical outcomes.

Keywords

Elimination Reactions: Chemical reactions in which a molecule loses a small molecule (usually HX) to form a double bond or a triple bond.

Dehydration of Alkenes: An elimination reaction in which water is removed

Cis Addition: The addition of two substituents to adjacent carbons of an alkene on the same side.

MCQs

1. Which reaction is commonly used for the synthesis of alkenes through the removal of water from alcohols?
 - a) Dehydration
 - b) Hydrogenation
 - c) Ozonolysis
 - d) Hydroboration

Answer: A

2. Which elimination reaction involves the removal of a hydrogen halide from an alkyl halide following Saytzeff's rule?
 - a) Dehydration
 - b) Dehydrohalogenation
 - c) Hydrogenation
 - d) Ozonolysis

Answer: B

3. Which addition reaction of alkenes involves the addition of bromine to form a trans product?
- a) cis-addition
 - b) trans-addition
 - c) Markovnikoff's addition
 - d) Anti-Markovnikoff's addition

Answer: B

4. What is the product of the ozonolysis of ethene (ethylene)?
- a) Ethanol
 - b) Ethanal
 - c) Ethanoic acid
 - d) Ethylene glycol

Answer B

5. Which of the following is not a method for the preparation of alkenes up to five carbons?
- a) Dehydration of alcohols
 - b) Dehydrohalogenation of alkyl halides
 - c) Partial catalytic hydrogenation
 - d) Kolbe's synthesis

Answer: D

6. What is the product of the hydration of propene (propylene)?
- a) Propanol
 - b) Propanal
 - c) Propanone
 - d) Isopropanol

Answer: D

7. Which addition reaction of alkenes results in the formation of an alcohol?
- a) Ozonolysis
 - b) Hydrogenation
 - c) Hydration

d) Hydroboration-oxidation

Answer: C

Self-assessment

1. Discuss the process of dehydration as a method for preparing alkenes.
2. Describe the partial catalytic hydrogenation method for the preparation of cis alkenes.
3. Explain the concept of cis and trans addition reactions in alkene chemistry.
4. Discuss the mechanism of Markovnikoff's and anti-Markovnikoff's addition of HX to alkenes.
5. Describe the hydration reaction of alkenes and its mechanism.

Reference

1. T-1: McMurry J. (2023). Organic chemistry (Tenth). OpenStax. Retrieved December 13 2023.
2. T-2: Huheey, J.E.; Keiter, E.; Keiter, R. (2009), Inorganic Chemistry: Principles of Structure and Reactivity, Pearson Publication. R-1: Atkins, P.W.; Overton, T.L.; Rourke, J.P.; Weller, M.T.; Armstrong, F.A.(2010), Shriver and Atkin's Inorganic Chemistry, Oxford R-2: B S Bahl & Arun Bahl (2022). Textbook of organic chemistry. S CHAND & CO LTD.
3. Clayden; Greeves, Warren (Second Edition). Organic Chemistry. Oxford University Press.
4. Robert Thomson Morrison, Robert Neilson Boyd (2011) 7th Edition. Organic Chemistry. Pearson.